



MILLENNIUM EDITION II



Lithco Inc.
Since 1963



SUPPLIES

TOOLS

EQUIPMENT



OFFSET PRINTING

DIGITAL PRINTING

SCREEN PRINTING

GRAPHIC DESIGN

REPROGRAPHICS

BINDERY & FINISHING



TOOLS OF THE TRADE

DIGITAL

PREPRESS

CHEMICALS

PRESSROOM

BINDERY

SAFETY



Sold by Graphic Arts Dealers Worldwide



WELCOME



Welcome to the newest, expanded **LITHCO CATALOG — MILLENNIUM EDITION II**. Not content with an award and industry kudos for our last catalog, we have been hard at work for over a year to bring you this even more comprehensive and improved version. With this publication, we once again reinforce our commitment to you, your graphic arts dealer and the manufacturers we are proud to represent.

We have broadened our product offering, adding forty-five new manufacturers and more than one hundred and seventy-five new products. Many of these product lines are in the electronic prepress, digital imaging and quality control areas. In addition we have significantly expanded our Tools of the Trade, Pressroom and Bindery Sections.

Our catalog is a valuable reference guide with information and tips to assist you in choosing the correct products for your needs. We have also expanded the use of web links so you can easily access more in-depth product information. Most importantly, use our catalog to specify products when ordering from your dealer.

As a Master Distributor supporting your Dealer, our mission is to provide the broadest selection of the highest quality products to the printing and imaging community — worldwide! You can find **LITHCO** on the Internet at www.lithcoinc.com. Visit us often for new product announcements, product tips, and special promotions.





We thank you for your support over the past thirty-eight years, and look forward to continuing and expanding our relationship.

Sincerely,

Stuart H. Simon
CEO

Jeff D. Simon
President

In addition to offering a very broad range of branded products, we have developed our own line of quality products that proudly carry the LITHCO name. Look for these:

	Magnifiers 7		Chain Cleaner & Lubricant 65
	LithcoJET™ Ink Jet Media 38		Aerosols 67
	Registration Systems 50		Premium Blue Blankets 68
	LithoProof™ Blue Proofing Paper 54		Correct-a-Plate™ Pens 88
	Chemicals 58		Gloves 104

All products carry manufacturer warranties.
Lithco brand products carry our unconditional guarantee:
If you are not satisfied with the performance of any Lithco product, we will replace it or refund your money!



Tel: **310-559-7770 ■ 800-454-8426**

Fax: **310-559-6908 ■ 888-454-8426**

Web: www.lithcoinc.com

Email: lithco@lithcoinc.com

Look for the following icons:



New and improved items for this edition.



Product Tips and Ideas.



Total Quality Management, ISO Certified and Computer-to-Plate products.



See our web links for additional product and application information.

Lithco, Inc. is proud of its membership affiliations with the following trade organizations:



We wish to thank our manufacturers for their support as well as the following for their efforts in the preparation of this catalog:

- PHOTOGRAPHY/COPYWRITINGGeorge Hammond
- ART PRODUCTION Presentation Media, Inc.
- EDITING Emily Moser, Jeff Simon
- SCANNING, PREPRESS & PRINTING Insync Media

The specifications for products within this catalog were accurate at time of printing. Specifications are subject to manufacturer's change without notice. Neither Lithco, nor the manufacturer, shall be held responsible for errors in typography, specification changes or product discontinuations. Buyer assumes all responsibility for determination of suitability of a product for a given purpose.

Contact your dealer for pricing, order minimums/multiples, freight charges and other purchase terms and conditions.

W
E
L
C
O
M
E

TABLE OF CONTENTS

T
A
B
L
E
O
F
C
O
N
T
E
N
T
S

ROUTE TO:

- Purchasing*
- Graphic Design*
- Digital Services*
- Prepress*
- Proofing*
- Pressroom*
- Bindery*
- Safety*



TOOLS OF THE TRADE 2



DIGITAL 35



PREPRESS 43



CHEMICALS 57



PRESSROOM 68



BINDERY 92



SAFETY 104



MISCELLANEOUS 109



INDEX 120

Here are just some of the new product lines being offered in this edition of our catalog. 



Looking for hard to find supply items? This catalog represents just a portion of our extensive line. Give us a call and we'll let you know if we have it, or if we can help locate the particular item you must have.

PANTONE®

As the worldwide leader in establishing color standards, Pantone, Inc. has significantly improved their product line to include new colors, brighter paper, additional paper stocks and a bold new presentation. These product improvements provide a wider usage over a more varied range of media. Don't be caught short when your customers specify the new colors.

PANTONE formula guide printer edition PANTONE formula guide matte edition PANTONE formula guide designer edition

Features 147 new, designer-inspired colors, plus 14 metallics

With 1,114 solid PANTONE Colors, the formula guides are the core of the industry standard PANTONE MATCHING SYSTEM®. The printer edition displays colors on both coated and uncoated stock, along with printing ink mixing formulations. As a result of increased use of matte finish papers, a matte edition is now available. The designer edition consists of three separate fan guides on coated, uncoated and matte stocks.

- A special icon indicates which solid colors may be accurately reproduced in 4-color process
- Printed on brighter paper stocks to reflect current paper trends
- The must-have tools for every printer, designer and service bureau

PART #	DESCRIPTION
PAN-CFGP	PANTONE formula guide printer edition
PAN-CFGM	PANTONE formula guide matte edition
PAN-CFGD	PANTONE formula guide designer edition



printer edition



designer edition – three guide set
matte edition also sold separately



PANTONE solid chips

The most accurate ink-on-paper reality check available

Use convenient tear-out chips to accurately specify your colors to others in the production line.

- Features 1,114 solid PANTONE Colors, including 147 new, solid colors and 14 metallics
- Six chips for each color
- Special icons identify colors that reproduce well in 4-color process
- Improved perforations for smoother edges and easier removal
- Brighter coated and uncoated stocks
- Available as a two book set (coated/uncoated) or a three book set that includes the new, matte edition along with the coated and uncoated versions
- Includes CD with new color values for input into desktop design/layout software



PART #	DESCRIPTION
PAN-SCCCU	PANTONE solid chips coated/uncoated
PAN-SCCCUM	PANTONE solid chips coated/uncoated/matte
PAN-SCCM	PANTONE solid chips matte

Individual replacement pages are available for all Chip Book formats. Order multiple – 12 of same page.

PANTONE hexachrome® guide

Experience levels of color accuracy not possible in traditional 4-color printing

Consists of enhanced CMYK plus PANTONE Hexachrome Green and PANTONE Hexachrome Orange. Hexachrome® is a fully integrated system with support in popular software products and proofing systems.

- Over 2,000 vivid Hexachrome color combinations
- Two-volume fan guide on coated and uncoated stock
- Includes CMYKOG screen values for each color
- Ensures accurate Hexachrome communication among designers, clients, separators and printers



PART #	DESCRIPTION
PAN-HCS	PANTONE hexachrome guide



See page 37 for Hexachrome Software.

PANTONE survival kits

The affordable way to own Pantone's most popular color guides

Choose from two different survival kits, depending upon your individual needs.

- Kits feature guides with new colors, brighter papers and new paper stocks
- Easy-to-carry, easy-to-use
- Newly designed, luggage-style carrying and storage case protects your valuable investment from premature wear and tear



FREE Case

New and improved functional case included with both Survival Kits. Ultimate Kit (SWOP) shown here.



These survival kits offer considerable savings over purchasing each item individually.

PANTONE survival kit	PANTONE ultimate survival kit
<ul style="list-style-type: none"> • PANTONE formula guide solid coated • PANTONE formula guide solid uncoated • PANTONE process guide coated • PANTONE solid to process guide • CD and carrying case 	<ul style="list-style-type: none"> • PANTONE formula guide solid coated • PANTONE formula guide solid uncoated • PANTONE formula guide solid matte • PANTONE process guide coated • PANTONE process guide uncoated • PANTONE solid to process guide • CD and carrying case

PART #	DESCRIPTION
PAN-CSK	PANTONE survival kit – SWOP
PAN-CSKE	PANTONE survival kit – EURO
PAN-UCSK	PANTONE ultimate survival kit – SWOP
PAN-UCSKE	PANTONE ultimate survival kit –

**EURO version does not include process guide uncoated*

 Visit our web site for monthly Pantone specials, and free loupe offer. Link #T301.

PANTONE solid in hexachrome guide

Eliminate the guesswork in determining which solid PANTONE Colors are achievable in Hexachrome

This guide shows 938 solid PANTONE MATCHING SYSTEM Colors printed in Hexachrome, plus the six basic Hexachrome Colors. Save money by deciding when Hexachrome printing is more economical than standard 4-color plus spot colors.

- Eliminates the need for spot color in many printing jobs
- Provides the screen tint percentages needed in Hexachrome printing
- Useful in matching logo colors and corporate printing standards
- Guide shows all colors on coated stock

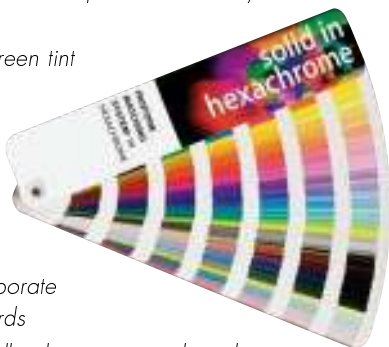

PANTONE process guide and chips book

Visualize over 3,000 CMYK color combinations on coated or uncoated stock

Designing in 4-color process? These publications give you an extensive palette of CMYK color combinations.

- Provides CMYK values for each color
- Accurate for CTP and conventional printing
- Colors displayed in chromatic order
- Printed in 175 line screens for higher resolution
- New screen angles match common industry usage
- KCMY print rotation for improved color accuracy
- Includes CD with CMYK screen values for input into design/layout software
- Chip books in two-book set provide four tear-out chips of each color on coated stock



PART #	DESCRIPTION
PAN-PCGS	PANTONE process guide set coated and uncoated SWOP
PAN-PCGC	PANTONE process guide coated SWOP
PAN-PCGU	PANTONE process guide uncoated SWOP 
PAN-PCGE	PANTONE process guide coated EURO
PAN-PCC	PANTONE process chips coated SWOP only

PART #	DESCRIPTION
PAN-SIH	PANTONE solid in hexachrome guide

PANTONE solid to process guide and chips book



Answer that critical question...

"How will that solid PANTONE Color look in process?"

Quickly visualize how 1,089 solid PANTONE Colors reproduce in 4-color process. Avoid costly, critical mistakes before making negatives, proofs or going to press.

- Side-by-side comparison of true, solid PANTONE Color vs. process color simulation
- Includes all 147 new PANTONE Colors
- Brighter, coated paper stock
- Provides CMYK values for each color
- Printed with 175 line screen for higher resolution
- Finer screen increments result in improved color matches
- Includes CD with CMYK screen values for input into design/layout software
- Accurate for both computer-to-plate (CTP) and conventional printing
- Individual replacement chip book pages available



PART #	DESCRIPTION
PAN-STP	PANTONE solid to process guide
PAN-STPC	PANTONE solid to process chips

PANTONE metallic guide + chips



For the shimmering, sophisticated look that only metallic colors deliver

Add the unique power and dramatic effect of metallics to your jobs. This color reference publication combines the best features of both a formula guide and a chip book into a single, convenient fan deck format.

- Contains 204 dazzling metallic colors, each with two tear-out chips on coated stock
- Metallic colors are chromatically arranged for quick, easy reference
- Each metallic color has a specific PANTONE Number and ink formulation
- Each color shown with and without varnish



PART #	DESCRIPTION
PAN-MCGC	PANTONE metallic guide + chips

PANTONE tints



Take the guesswork out of tints of PANTONE Colors

Displays tints of 1,089 solid PANTONE Colors, including difficult to visualize halftones.

- Includes 147 new colors
- Shows tints of each color from 10% to 80%
- Features over 31,000 color effects on coated and uncoated stock
- Determine the readability of reverse type or color and black surprinting
- Provides accurate tint information for input into your design software
- Two-book set



PART #	DESCRIPTION
PAN-CTS	PANTONE tints coated/uncoated

PANTONE pastel formula guide + chips



Incorporate the soft, delicate touch of pastels in your design work

This color reference publication combines the best features of both a formula guide and a chip book into a single, convenient fan deck format.

- 126 pastel colors, each with two tear-out chips on coated and uncoated stock
- Fan format allows designers to compare and consider full range of pastel colors
- Chips attached to artwork assure accurate color communication
- Includes ink mixing formulas

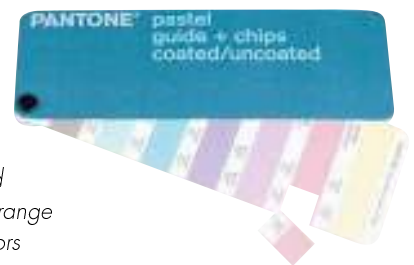

PART #	DESCRIPTION
PAN-PASFCG	PANTONE pastel formula guide + chips

PANTONE foil stamping guide

At last...a standard guide for the foil stamping industry!

Contains 112 hot stamping foil colors on coated stock and 72 colors on uncoated stock for quick and easy foil selection by foil stampers, printers, designers and other graphic arts professionals.

- Easy selection of the right metallic foil color
- Unique PANTONE Numbering System for accurate identification
- Guide indicates golds, silvers, metallized, pigmented and pearlescent colors



PANTONE Colors and Black for Adobe® Photoshop®

Solve the confusion of working with duotones in Adobe® Photoshop®

Simplifies working with duotones and ensures that you get the results you want. Available in two versions, designed to meet individual needs.

- Two fan-guide set on coated and uncoated stock
- Includes cross-platform MAC®/Windows® CD for loading and applying duotone curves in Adobe Photoshop
- Standard Edition previews over 600 PANTONE color and black duotone combinations in printed and digital form, displays 12 duotone combinations for each of 50 PANTONE MATCHING SYSTEM Colors
- Studio Edition contains the two guides, plus five CDs containing over 13,000 duotone curves for over 1,000 PANTONE MATCHING SYSTEM® Colors



STUDIO EDITION SHOWN

PART #	DESCRIPTION
PAN-FSCG	PANTONE foil stamping guide

PART #	DESCRIPTION
PAN-DG	PANTONE Colors and Black for Adobe Photoshop
PAN-DGSE	PANTONE Colors and Black Studio Edition NEW

CMYK Quadtone Kit for Photoshop **NEW**

Pick an effect, apply the curve and you are done – within seconds!

This handy 198-page full-color selection guide illustrates more than 2,300 process ink quadtones, tritones, and duotones created in Photoshop. A Mac/Win format CD contains all 2,300 Photoshop duotone curves illustrated in the selection guide.

- Greatly reduces the amount of time spent playing "What-if" video games in Photoshop
- Improves communication of visual ideas between clients, designers, and production staff — when a client asks for blue, everyone can see which blue the client wants
- Reduces quadtone surprises at press time caused by guesswork in creating effects on a monitor that are destined for print
- Pickerbook's duotone curves on CD provide faster, more accurate, and more consistent, repeatable results



PART #	DESCRIPTION
PAN-QT	CMYK Quadtone Kit



DCS® Books: Professional Edition & Mini Editions



Eliminate trial-and-error CMYK color matches

The difference in appearance of color when viewed in different color spaces represents one of the greatest problems in prepress. Do not be misled by the RGB colors on your monitor when you are really trying to achieve CMYK on paper. The Digital Color Scale Books (DCS) show you *in advance* how the ink-on-paper will look. Tens of thousands of color combinations are available. The basic combination on all pages is the mixing of cyan and magenta, with yellow and black overprinted. The chromatic organization of the DCS is in ascending percentages of yellow.

- ▶ Use the printed color mixes to dial-in the correct CMYK values to achieve your desired ink-on-paper results
- ▶ Quick access tabs indicating yellow percentages make finding your desired color quick and easy

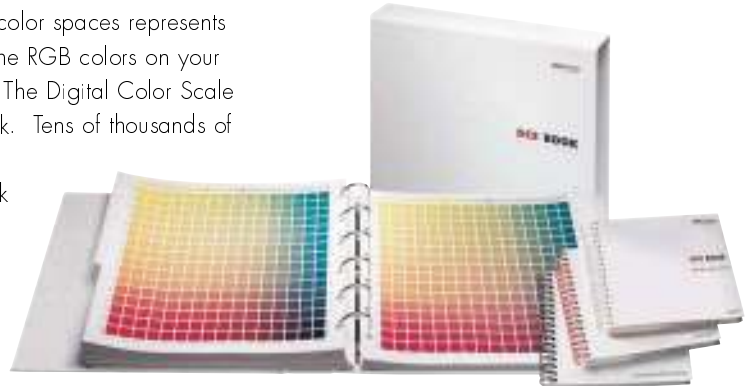

AVAILABLE IN TWO VERSIONS – PROFESSIONAL AND MINI EDITIONS

PROFESSIONAL EDITION	MINI EDITIONS
<ul style="list-style-type: none"> ▶ Displays 57,344 different color combinations on large 13" x 12¾" Stock ▶ Printed on coated stock, one side only to eliminate show through ▶ CMYK are shown in the following percentages: 0, 5, 10, 15, 20, 25, 30, 35, 40, 45, 50, 60, 70, 80, 90 and 100 (solid) ▶ Extensive Foreword on the fundamentals and key concepts of Color ▶ Appendix contains gray value gradations of 10 to 95% in ten different screen rulings and now includes CIE Lab and L*A*B color scales 	<ul style="list-style-type: none"> ▶ Displays 20,736 different color combinations on compact 8¾" x 8¾" stock ▶ Available on coated, uncoated or newsprint/recycled stock ▶ CMYK are shown in the following percentages: 0, 5, 10, 20, 30, 40, 50, 60, 70, 80, 90 and 100 (solid) ▶ Available individually or as a complete, three book set

The DCS Book can be used in two ways...



To compare values provided by the color picker



As a color selector

Although this image looks good on the screen you find there is too much red in the facial tones when printed

1 Check the colors in print against the values provided by the color picker.



2 Based on your evaluation of the DCS color patches, you choose a value that has 20% less magenta.

2



3 Apply the new value for an optimal print result.

3



PART #	DESCRIPTION	STOCK
MIS-DCSPRO	DCS Book – Professional Edition	Coated
MIS-DCSMC	DCS Book – Mini Edition	Coated
MIS-DCSMU	DCS Book – Mini Edition	Uncoated
MIS-DCSMN	DCS Book – Mini Edition	Newsprint
MIS-DCSMS	DCS Book – Mini Edition Set	Set



Also ask about DCS software.

- ▶ DCS Calibrator kit
- ▶ DCS Standard ICC Profiler for better separations
- ▶ Autocolor profiling plug-in for Photoshop

OPTICS - Magnifiers & Scopes

Lithco offers the most diversified line of magnifiers and microscopes for graphic arts and printing professionals. The optics presented are industry benchmarks for excellence.

All Lithco optics are the highest quality obtainable. Many feature achromatic and color corrected lenses as well as flat fields to reduce distortion.



Power: The number of times a lens or lenses multiplies an image with respect to the original size. Low power is recommended for scanning large surfaces. Higher powers are generally used for inspecting small areas.

Field of View: The maximum area seen through a magnifier. The entire field of view may not be in focus. See Flatness of Field.

Flatness of Field: Due to the physical laws of optics, the outer part of the image formed by a lens may be out of focus. The greater the power and curvature of the lens, the more pronounced this problem becomes. Magnifiers with multiple lenses can reduce this problem. The visible area that appears in focus is the flat field.

Working Distance: The distance from the magnifier lens to the object being viewed. As magnification power increases, the working distance decreases.

Aberration: This is distortion caused by the lens. Spherical aberration is distortion of the image, as explained in Flatness of Field. Chromatic aberration is distortion of colors being viewed, as explained in Color Distortion.

Color Distortion: Lenses produce a prism effect, which causes the image to develop false color fringes. This is due to the fact that different colors focus at different points. Achromatic lenses correct this problem by focusing many colors at the same point.

Parallax: Parallax is the apparent misalignment of two different items when viewed from an angle. It is the cause of improper registration when stripping multiple color jobs. Parallax is eliminated when viewing straight down on registration marks instead of from a slight angle.

Coated Lens: A coated lens helps to minimize or eliminate color distortion caused by different colors focusing at different locations. Optimum color viewing is obtained from coated achromatic lenses.



Use the helpful technical information here in addition to the magnifier recommendation chart on our web site to help you choose the correct magnifier for your needs. [Link #T701](#)

Types of Lenses:



➤ **Simple Positive Lens** – A single piece of optical glass or acrylic with two convex surfaces (curved outward). Designed for low magnification.



➤ **Simple Negative Lens** – A single piece of optical glass or acrylic with two concave surfaces (curved inward) used in conjunction with positive lenses.

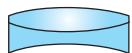

➤ **Achromatic Lens** – A positive simple lens cemented to a negative simple lens. Achromatic lenses are corrected for two colors and produce flatter fields of view at higher powers.



➤ **Double Lens** – Two simple lenses used as a system but not cemented together. This system produces a far superior image than a simple lens.

Lithco LithoMag Folding Loupes

Available in three different magnifications to match your needs

These are the best general-purpose magnifiers for use in all areas of graphic arts production from pre-press to press. **All** feature achromatic lens systems that can be focused for individual eyesight. **All** have fully color corrected lenses.

- Lens folds into sturdy base which acts as a carry case
- Lock-ring on lens maintains focus
- Ample, hands-free working space under 10X and 12X models
- 12X also features an extra-wide field of view lens
- Includes protective pouch



PART #	POWER	DESCRIPTION	LENS
OPT-LM10	10X	LithoMag	Coated Achromatic
OPT-LM12	12X	LithoMag – Extra-Wide Field	Coated Achromatic
OPT-LM20	20X	LithoMag	Coated Achromatic

LITHCO OPTICS



1/2" 3/4" 1"

Lithco Linen Testers

All linen testers are not created equal...**these** are the best

Lithco Linen Testers are the finest quality available. Double glass lens system mounted in a cast zinc frame assures a uniform flat field that is always in sharp focus.

- The most popular magnifiers – found in print shops worldwide
- Enhanced lens system brightens image for easier viewing
- 1/2", 3/4", 1" and 2" sold with convenient vinyl carrying case
- Also available, 4" x 4" Linen Tester with single acrylic lens and plastic frame



2" 4"



Lithco 12X Plastic Base Loupe

A real pre-press gem, beautifully designed in crystal clear acrylic

Use this magnifier in the darkroom to focus your camera on the ground glass or check film development without scratching the emulsion. Ideal on the stripping table – large working distance and an **extra-wide**, flat field of view.

- Fully color-corrected, achromatic lens system
- Adjustable focus with lock-ring
- Clear plastic base for shadowless viewing

PART #	DESCRIPTION
OPT-PB12	12X Plastic Base Loupe w/Extra-Wide Field



Lithco 10X Folding Chrome Linen Tester NEW

This spring-loaded optical instrument pops open for instant use. It is bright chrome plated on a solid brass frame. Includes a protective case.

PART #	POWER	DESCRIPTION	LENS
OPT-LT1/2	10X	1/2" x 1/2" Linen Tester	Double Glass
OPT-LT3/4	8X	3/4" x 3/4" Linen Tester	Double Glass
OPT-LT1	6X	1" x 1" Linen Tester	Double Glass
OPT-LT2	4X	2" x 2" Linen Tester	Double Glass
OPT-LT4	2X	4" x 4" Linen Tester	Single Acrylic
OPT-LTC1/2	10X	1/2" x 1/2" Folding Chrome Linen Tester	Single Glass

Octagon Anti-Parallax Loupes NEW

Align critical registration marks with maximum accuracy and ease

Don't let misaligned register marks ruin a job. The Octagon loupes are designed as collimating magnifiers to eliminate parallax and assure accurate registration. Includes a zippered vinyl storage pouch.

PART #	POWER	DESCRIPTION
OPT-OG10	10X	Octagon Anti-parallax Loupe
OPT-OG15	15X	Octagon Anti-parallax Loupe



Lithco 8X Type Size Finder

More accurate and faster than an "E" scale

A built-in scale measures type up to 72 point. "Quick-Scales" for type from 4 point to 36 point shows CAP size as well as full point size. Always measure a rounded capital letter such as a C, G, O or S to ensure accuracy.

- 8X magnification makes reading small type easy
- Focusing acrylic lens



HANDY TIP

Some things get better with age, some things don't. Is it time to replace your old PANTONE formula guide? See page 2.



Lithco 8X EconoLoupes – Standard and Wide Field

Quality loupes at an economical price

These are the perfect loupes for all those places where you need an “extra” loupe. Useful for students, photographers, teachers and “the front counter.”

- Wide field, single acrylic lens
- Clear plastic base for shadowless viewing
- Wide Field model supplied with black vinyl zippered pouch
- Focusing unit also available – same as pictured below, no reticle

PART #	DESCRIPTION
OPT-EL8	8X EconoLoupe – “Standard” Style
OPT-EL8WF	8X EconoLoupe – Wide Field
OPT-EL8F	8X Focusing EconoLoupe



PART #	DESCRIPTION
OPT-TF8	8X Type Size Finder

Lithco 12X Swing-Base Magnifier

The best at a very attractive price!

The Lithco Swing-Base Magnifier is a favorite among serious pre-press professionals. It features a color-corrected, achromatic lens with adjustable, locking focus ring.

- Ample, hands-free working space
- Wide field lens



PART #	DESCRIPTION	LENS
OPT-LSB12	12X Swing-Base Extra-Wide Field	Coated Achromatic

Lithco 6X Wide Field Magnifier

Advanced aspherical design for stripping, opaquing and touch-up work

Unique design allows you ample working distance under the lens. Clear acrylic base gathers light to brighten image. The adjustable-focus, aspherical lenses deliver a wide, flat field of view from edge to edge by simply moving the eye. A lens cap is included to protect the top optical surface.



PART #	DESCRIPTION
OPT-WFM6	6X Wide Field Magnifier

5X Round Stand Magnifier



Aspheric lens for distortion-free viewing over the entire lens area

A powerful 5X aspheric lens is mounted in a pre-focused stand, allowing you to view a 60 mm area. Perfect for viewing color transparencies on a viewer or light box.



PART #	DESCRIPTION
OPT-RSM5	5X Round Stand Magnifier

Many Lithco Magnifiers are available with custom imprinting making them the perfect promotional giveaway. Please inquire about details.



PEAK OPTICS

PEAK OPTICS

Peak is one of the leading manufacturers of quality magnifiers and optical goods in the world. Lithco is pleased to present their products for your use.

Peak Swing-Base Loupes 15X and 22X



The finest swing-base units you can buy

These loupes feature color-corrected, achromatic glass lenses that virtually eliminate color aberration. The 15X is free of spherical aberration, and features precision focusing. A sturdy leatherette carry case protects the unit.

Peak 8X 35 mm Format Magnifier

Designed for viewing 35 mm negatives and transparencies

This magnifier fully covers the 24 mm x 36 mm area of the 35 mm format. Its clear plastic skirt prevents shadows.

- ▶ Graduations on the skirt facilitate placement of crop marks to use in enlargements
- ▶ Acrylic lens focuses for individual eyesight
- ▶ Includes cord to hang magnifier around neck when working with medium and large format cameras and focusing on ground glass



Peak Anastigmatic Measuring Loupe 4X



Anastigmatic loupes are known for extremely sharp center-to-edge clarity and the entire field may be viewed by merely moving the eye. High-resolution achromatic lens system with focusing from -2 to +2 diopters. Comes with measuring reticle that covers a 2" range in .005" increments. Fully coated for color corrected, flat field viewing. Smooth helicoid twistfocus mechanism is similar to the focus on

premium camera lenses. Recommended for inspecting color transparencies, proofs and process color printing.

Peak Fixed Focus Loupes

▶ 5X, 10X, 15X and 22X

Bright, sharp, loupes with a 360° clear acrylic base to admit light from all directions.

- ▶ 5X has a simple optical glass lens
- ▶ 10X features a two-element optical glass lens
- ▶ 15X utilizes a three-element, two-group achromatic optical glass construction
- ▶ 22X features a four-element, three-group achromatic optical glass lens construction
- ▶ Both 15X and 22X are ideal for registration, trapping and slur checks in color printing

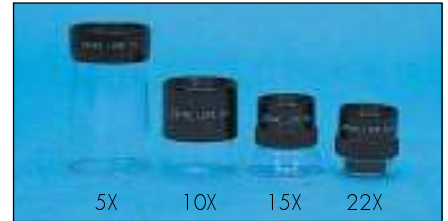

Peak Square Format Focus Loupe 4X



Designed for medium-format photography, this loupe allows you to view the entire frame of 120/220 format film. Supplied with interchangeable bases; use the clear base when viewing without an external light source, or the opaque black base on a light table or camera back. Supplied with a lens cap and removable neck strap.

Peak Plasti-Loupe 10X



A single-lens, fixed focus loupe with a clear acrylic skirt. Economical price **AND** quality optics make this another Lithco Best Buy.

PEAK OPTICS			
PART #	POWER	DESCRIPTION	LENS
OPT-PSB15	15X	Swing-Base Loupe	Coated Glass Achromatic
OPT-PSB22	22X	Swing-Base Loupe	Coated Glass Achromatic
OPT-PH8	8X	35 mm Format Magnifier	Three Element
OPT-P19904	4X	Anastigmat Loupe	Coated Achromatic
OPT-P1960	5X	Fixed Focus Loupe	Simple Glass
OPT-P1961	10X	Fixed Focus Loupe	Achromatic
OPT-P1962	15X	High-Resolution Loupe	Achromatic
OPT-P1964	22X	High-Resolution Loupe	Coated Achromatic
OPT-P2038	4X	Square Format Focus Loupe	Coated Achromatic
OPT-P2032	10X	Plasti-Loupe	Simple Acrylic

Peak Depth Measuring Microscopes

Maximum magnification in a compact scope

Precision measuring microscopes for lineal as well as depth measurements. Will focus on two different planes and measure vertical distance between them, accurate to 0.1 mm. Handy for checking registration marks on stacked films or color proof overlays.

Available in 25X, 50X, 75X and 100X, with inch or metric scales. Comes in a durable plastic, foam-lined carry case.



Peak Pocket Microscopes

Fits in your pocket as easily as a pen

These powerful microscopes are no larger than a pen. They are available in magnifications of 25X, 50X, 75X and 100X, with

or without metric measuring reticles. Best suited for high power viewing of small areas, checking registration or viewing printed circuit boards.



Peak Wide Stand Measuring Microscopes

► **60X, 100X, 150X and 200X**

A wide field of view with superior resolution

These scopes feature a smooth helicoid focusing mechanism and penlight illumination. Clear acrylic skirt admits light from all directions. Graduated metric dial on focusing ring for depth measurements in addition to measuring reticles. Coated achromatic lenses. Excellent for quality control checks on printed circuit boards. Available with inch or metric scale.



Peak Shop Microscopes

► **60X and 100X**

High resolution, smooth focusing, penlight illumination and their compact size make these scopes valuable quality control tools throughout the shop. Durable and sturdy, the metallic base is designed for the rigors of daily shop use. Comes with measuring reticle. Use to check printed circuit boards, universal bar codes or magnetic check imprints. Please specify inch or metric scale when ordering.

PEAK MICROSCOPES

PART #	POWER	DESCRIPTION	MEASURING RANGE	SCALE DIVISIONS
OPT-DMR25*	25X	Depth Measuring Scope	.118"	.0020"
OPT-DMR50*	50X	Depth Measuring Scope	.063"	.0010"
OPT-DMR75*	75X	Depth Measuring Scope	.039"	.0005"
OPT-DMR100*	100X	Depth Measuring Scope	.031"	.0005"
OPT-LS60*	60X	Shop Microscope	.10"	.001"
OPT-LS100*	100X	Shop Microscope	.05"	.0005"
OPT-PM25	25X	Pocket Microscope	N/A	w/o Reticle
OPT-PMR25	25X	Pocket Microscope	3.0 mm	.05 mm
OPT-PM50	50X	Pocket Microscope	N/A	w/o Reticle
OPT-PMR50	50X	Pocket Microscope	1.6 mm	.05 mm
OPT-PM75	75X	Pocket Microscope	N/A	w/o Reticle
OPT-PM100	100X	Pocket Microscope	N/A	w/o Reticle
OPT-P203460*	60X	Wide Stand Scope	.080"	.0010"
OPT-P2034100*	100X	Wide Stand Scope	.050"	.0005"
OPT-P2034150*	150X	Wide Stand Scope	.035"	.0002"
OPT-P2034200*	200X	Wide Stand Scope	.024"	.0001"

*Metric scale available. Please add "M" to the part number when ordering, such as OPT-DMR50M.

SKS & SPECIALTY OPTICS

SKS OPTICS

SKS loupes and microscopes offer high performance, yet are simplified practical instruments with very sharp resolution. The observed image is very clear as the result of careful optical correction. All of the SKS loupes and scopes offered by Lithco feature top quality optically ground glass lenses.



J-10 and J-15 Loupes

These are economically priced focusing loupes. Simply turn the top ring and adjust. Clear plastic skirt allows for even, shadow-free viewing.



IOX Pocket Comparator

This loupe contains a triplet lens system, which provides an extremely flat field of view over the entire reticle area. This insures precise measurements. An etched glass, interchangeable reticle provided at the bottom of the plastic skirt enables simple, accurate and direct measurements. Standard scale ranges from 0 to 0.8" in .0025" increments. Comes with a semi-rigid carry case. Also available with a metric scale. Optional, interchangeable reticles



are available; please refer to our web link #T121 for specific configurations. A convenient angle-measuring reticle is listed in the table below.



SKS Stand Microscopes

These highly accurate, compact, precision microscopes offer sharp, bright images. Features include fully coated optics and precision focusing. Available with or without measuring reticles. The reticle for the 25X ranges from 0 to .12" in .002" increments. The 50X ranges from 0 to .06" in .001" increments. Also available with metric scales.



Paragon IOX

A flat field of view, locking focus ring and color correction make this magnifier a perennial favorite with prep department and pressroom professionals. Lens folds into protective case to prevent scratching.



Tobias Paramag

► 7X and 10X

Designed for multi-color stripping, the design of the Paramag eliminates parallax, assuring accurate line-up of register marks on stacked flats. Lens focuses by sliding in the clear acrylic outer sleeve.

SPECIALTY OPTICS	
PART #	POWER
OPT-PAR	10X
OPT-PM7	7X
OPT-PM10	10X
OPT-SM7	7X
OPT-SM10	10X
OPT-SM12	12X
OPT-P30	30X

SKS OPTICS				
PART #	POWER	DESCRIPTION	MEASURING RANGE	SCALE DIVISIONS
OPT-J10	10X	Focusing Loupe	N/A	w/o Reticle
OPT-J15	15X	Focusing Loupe	N/A	w/o Reticle
OPT-SD10*	10X	Pocket Comparator	.8"	.0025"
OPT-SD10RET5	10X	Angle Reticle for Comparator	0° - 90°	5° NEW
OPT-SM25	25X	Stand Microscope	N/A	w/o Reticle
OPT-SMR25*	25X	Measuring Stand Microscope	.12"	.002"
OPT-SM50	50X	Stand Microscope	N/A	w/o Reticle
OPT-SMR50*	50X	Measuring Stand Microscope	.06"	.001"

*Inch reticle standard. For metric reticle, add "M" to the part number, such as OPTSMR50M

HANDY TIP

A collimating magnifier is the start to accurate registration. You also need the

Stripmaster

► 7X, 10X and 12X

This unique magnifier eliminates parallax. Screw type positive focusing, with lock ring to hold focus. Highly recommended for all critical color work where accurate registration is a must.



Illuminated Pocket Microscope

► 30X

Compact 30X scope easily fits in your pocket, purse or briefcase. Adjustable focus lens is illuminated by a built-in light source. Requires two AA batteries, not included.



BETA OPTICS

Lithco is pleased to offer specially selected Beta optics. All feature color corrected, achromatic lenses with adjustable focus and lock rings. Magnifications of 10X and 12X have flat fields.



PART #	POWER	DESCRIPTION
OPT-BM10	10X	Betamag Folding Loupe
OPT-BM12WF	12X	Betamag Folding Loupe – Wide Field
OPT-BM20	20X	Betamag Folding Loupe
OPT-BSB10	10X	Beta Swing Base Loupe
OPT-BSB12	12X	Beta Swing Base Loupe – Wide Field
OPT-BSB20	20X	Beta Swing Base Loupe
OPT-BV10	10X	Betaview
OPT-BV12	12X	Betaview - Wide Field
OPT-BV20	20X	Betaview
OPT-BRP12	12X	Beta Register Pro 12 NEW



More Beta products pages 14 & 15.
The full range of Beta screen tints is also available.

Beta Color Viewer II



See each process color individually and in high contrast

Now you can easily detect common press and proofing problems. The Beta Color Viewer II is a unique visual instrument that utilizes color separation filters, a high-intensity light source, and a unique optical system. Sold complete with rechargeable ni-cad batteries and AC adapter. The most important tool since the densitometer!



- Allows you to see a 0.5% yellow dot
- Measure line width, dot placement, and register error easily and accurately
- Highly recommended for all proofing systems, including Iris and other inkjet systems
- Choose magnifications from 10X up to 100X
- An excellent TQM tool
- Five year warranty against manufacturing defects, excluding bulb and battery

PART #	POWER	RETICLE
OPT-CPV10	10X	None
OPT-CPV20	20X	None
OPT-CPV25*	25X	Inch
OPT-CPV50*	50X	Inch
OPT-CPV75*	75X	Inch
OPT-CPV100*	100X	Inch

Note: All units come standard with 110v adapter, 220v adapter also available.

* Inch reticle standard, also available with metric reticle – add "M" to the part number when ordering, such as OPT-CPV50M.

DESCRIPTION	LENS
Paragon Fold-out Loupe	Coated Achromatic
Tobias Paramag	Coated Achromatic
Tobias Paramag	Coated Achromatic
Stripmaster NEW	Coated Achromatic
Stripmaster NEW	Coated Achromatic
Stripmaster	Coated Achromatic
Illuminated Pocket Microscope	Focusing Simple Lenses

proper pins, tabs and hole strengtheners to finish the job. See pages 50 & 51 for all your registration needs.

BETA

Beta Ultra Dottie Halftone Analyzer



Ask about
Beta's 10-Day Trial

Eliminates optical dot gain

This next generation QC instrument departs from conventional densitometers in that it is an image based Quality Control instrument for halftone measurement of Computer-To-Plate (CTP), conventional plates, film, and color print materials. The Beta Ultra Dottie is the most advanced and easy-to-use halftone image analyzer on the market. Operating at more than twice the resolution of any other portable instrument, the 12,000 dpi imager easily measures conventional halftone screens up to 400 lpi and stochastic pixels smaller than 20 microns.

- ▶ Graphic/visual display of dot image area in two modes, for visual inspection and critical evaluation
- ▶ Screen angle, dot diameter and line ruling indicated
- ▶ Calibration data plotted directly on the display
- ▶ Image and data capture for download and analysis
- ▶ LED illuminator uses 15 monochromatic elements to provide perfectly uniform and non-directional color separation illumination, eliminating directional effects as a potential source of measurement error
- ▶ Aggressive power management software and low power design enable over a half-million measurements on one set of "AA" alkaline batteries – no need for a battery charger to break or misplace
- ▶ No power hungry, potentially troublesome CCD (charge coupled device) – CMOS (complimentary metal oxide semiconductor), allows for much lower power consumption and a wider dynamic range



BETA INDUSTRIES

Solutions for full service quality control in print production

The Beta name has always represented quality and value. The latest offerings in halftone analyzers, reflection and transmission densitometers and Beta Quality Control Kits® continue their tradition of state-of-the-art technology in Total Quality Management instrumentation.

Plate Reading Densitometers

Dedicated plate reading densitometers

Betalog Platemaster – Measure dot area and density on offset plates, regardless of color, contrast, or graining. Unique optical system eliminates errors from plate grain. Serial data port included.

Betalog Platemaster DP – Same as above, with Yule/Neilson 'n' factor.

Beta "S" Series Color Reflection Densitometers

Easy-to-use units for every level and type of press have advanced features



The latest generation BetaColor reflection densitometers are sophisticated, yet user-friendly instruments that require zero maintenance. Unique to Beta, these are the only densitometers that indicate the order of trap sequence.

- ▶ Most commonly used features such as density, dot gain and trap are done in automatic mode
- ▶ One million plus readings from one set of "AA" alkaline batteries
- ▶ No recharging, no ports or cords to break or fray – saves weight, adds to durability
- ▶ Measurements given in 1/10th of a second
- ▶ Full customer service and support standard
- ▶ Competitively priced, limited seven year warranty on Perma Filters and Light Source

MODELS AVAILABLE

- ▶ **S1** – Features auto zero, density, density difference, color selection, serial data port
- ▶ **S2** – Has auto zero, density, density difference, color selection and auto dot gain at two levels, dot area, unique ergonomic design and serial data port
- ▶ **S4 (formerly BetaColor 950)** – Fully automatic, four-line display, balance function, options, unique first color recognition and trapping sequence, gray balance and serial data port
- ▶ **S4 Plus (formerly BetaColor 1000)** – All of the above features plus three dot gain levels, hue error, print contrast, grayness and absolute zero – the ultimate densitometer for critical pressroom control
- ▶ **BetaColor 2000 Spectrodensitometer** – Revolutionary spectrodensitometer for all color matching, proofing, pressroom applications, multi-line/multi-lingual display of Lab, LCH, Xyy, Delta E, 7-color hi-fi density dot gain, trap, Status-T densitometry and more
- ▶ **BetaColor 917** – Special simplified newspaper functions, supervisory mode setup and serial port



PART #	APPLICATION	DESCRIPTION
EQP-BUD	Color	Ultra Dottie Video Halftone Analyzer
EQP-BCS1	Color	BetaColor S1 Reflection Densitometer
EQP-BCS2	Color	BetaColor S2 Reflection Densitometer
EQP-BCS4	Color	BetaColor S4 Reflection Densitometer
EQP-BCS4P	Color	BetaColor S4 Plus Reflection Densitometer
EQP-BC2000	Color	BetaColor 2000 Spectrodensitometer
EQP-BC917	Color	BetaColor Newspaper Reflection Densitometer
EQP-BLPM	Plate	Betalog Platemaster
EQP-BLPMDP	Plate	Betalog Platemaster DP

Betalog Transmission Densitometers

Economical tools for Imagesetter calibration

All basic features in simple, compact portable units make Betalog Densitometers prepress favorites.

- *Betalog 77 – Transmission B&W density to 6.0, Pos/Neg dot area, soft dot, serial data port, use on any light table*
- *Betalog 130 – Combination transmission and reflection B&W density to 6.0, Pos/Neg dot area, serial data port, use on any light table with film or reflection mode for paper*
- *Betalog 150 – Transmission B&W density to 7.0, Pos/Neg dot area, built-in light source allows use anywhere, serial data port*



PART #	APPLICATION	DESCRIPTION
EQP-BL77	B&W	Betalog 77 Transmission Densitometer
EQP-BL130	B&W	Betalog 130 Transmission & Reflection Densitometer
EQP-BL150	B&W	Betalog 150 Transmission Densitometer

Beta Quality Control Kits®

See it...Measure it...Control it

The Beta series of press-specific kits is a three-point system where all components work interactively with each other to achieve fast and accurate press quality control. Packaged in an attractive and sturdy carrying case. The three parts of the system are:

1. *Unique Beta Gray Balance Custom Control Bar, the only color bar made to the exact specifications of your press – available as a digital (EPS) file or as film negatives.*
2. *A BetaColor reflection densitometer to read density, dot gain and other critical variables from the above color bar which is then visually verified by...*
3. *The Beta Color Viewer II which provides visual confirmation of the information supplied by the densitometer.*



Beta Custom Gray Balance Color Bars



The only bars made exactly for your press

These color bars are customized to match the size and width of any press ink keys. Each ink key zone contains the four color solids, a three color gray balance and a special target. For every adjustment key there is a corresponding measurement patch. One measurement of the gray balance target gives the same information that would normally require three density measurements and three dot gain measurements. Use a densitometer and a Beta Color Viewer to control color balance during the press run.

- *Special targets (Dot Gain, Resolution, and Trapping) are distributed across the bar for convenience*
- *Available in any width for any press*
- *Available as film negatives for conventional stripping or EPS files for CTF or CTP (supplied on PC formatted diskettes readable on all Mac and Windows systems)*

PART #	LENGTH	SPACING	FILM/FILE
BST-CB40K	40"	Komori	Film
BST-CB40H	40"	Heidelberg	Film
BST-CB40U	40"	Universal	Film
BST-CB30K	30"	Komori	Film
BST-CB30H	30"	Heidelberg	Film
BST-CB30U	30"	Universal	Film
BST-CB40HEPS	40"	Heidelberg	File
BST-CB40KEPS	40"	Komori	File
BST-CB20HEPS	20"	Heidelberg	File
BST-CB13REPS	13"	Ryobi	File

Color Bars are available for any press. Please inquire if your press is not listed.

PART #	DESCRIPTION	APPLICATION	COMPONENTS
EQP-BQCK2x	System 2	Two-Color Press	BetaColor S2, Color Viewer II, Custom Color Bar*
EQP-BQCK4x	System 4	Four-Color Press	BetaColor S4, Color Viewer II, Custom Color Bar*
EQP-BQCK4Px	System 4 Plus	Five+ Color Press	BetaColor S4 Plus, Color Viewer II, Custom Color Bar*

**Custom Color Bar is for a specific press, specify. This replaces the "x" in the part number.*

IHARA DENSITOMETERS

IHARA Color Reflection Densitometers



Save ink, paper and press time with these invaluable and economical TQM tools

Microcomputer technology allows IHARA Reflection Densitometers to feature quick calibration, menu driven commands and a repeatability factor which makes these the easiest units to use in the industry.

- Help key provides detailed explanations for all measurement functions along with answers to frequently asked questions
- Easy-to-read, large graphic LCD interactive display
- Auto-function allows measurement of density and dot gain interchangeably
- Security user code safeguards your investment
- Upgradeable design allows upgrade to a more advanced unit for a nominal fee
- Adjustable left or right-handed view
- Self-guiding prompts in English, Portuguese, Spanish, French, Swedish, German and Italian



R730 COLOR REFLECTION DENSITOMETER

Ask about our 14-Day Trial!

IHARA Densitometers

PART #/ MODEL	FEATURE														
	Density	Density Δ	Dot Area	Plate Dot Area	Dot Gain	Ink Trap	Print Contrast	Hue Error	Grayness	Brightness	Cast	Saturation	Dot Analysis	Auto-Function	Auto N-Value Selection
Color Reflection Densitometers - Models ending in "P" also have plate measuring functions															
EQP-IHR710	•	•													
EQP-IHR710P	•	•		•											•
EQP-IHR720	•	•	•		•									•	
EQP-IHR720P	•	•	•	•	•									•	•
EQP-IHR730	•	•	•		•	•	•	•	•	•	•	•	•	•	
EQP-IHR730P	•	•	•	•	•	•	•	•	•	•	•	•	•	•	•
B&W Reflection Densitometer															
EQP-IHR700	•	•	•		•		•						•		
B&W Transmission Densitometer															
EQP-IHT500	•		•												
B&W Combination Densitometer															
EQP-IHTR500	•		•												

Unless otherwise specified, all reflection densitometers come with Status-T response, 3.0 mm aperture, without polarization filter. An optional polarization filter is available for all reflection densitometers with 3.0 mm aperture. Please inquire.



P300 Plate Densitometer

The **Model P300** is excellent for measuring plate percentage dot area and density. It features automatic or manual selection of the N-value and a RS232C serial communication port for interface to a PC. The simple user interface on a large graphic LCD display is completely menu driven so no manual is required. Standard features are a 3.0 mm aperture and Filter Response Status T.

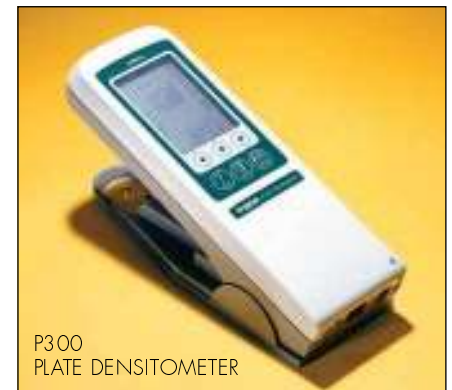

P300 PLATE DENSITOMETER

PART #	DESCRIPTION
EQP-IHP300	P300 Plate Densitometer

All IHARA densitometers feature:

- An 18 month limited warranty on parts and labor
- RS-232C serial port for connection to a PC or Ihara PR-95 Printer
- Manufacturer technical support
- Operation manual, calibration card and carrying case
- 120 VAC power supply
- Satisfaction guaranteed

The entire range of IHARA Spectrodensitometers is also available

DTP DEVICE & GLOSS METERS

SPECTROCAM



The ideal tool for color management and control applications

With its unique, patent-pending design, the Spectrocam exceeds the specifications of high-end spectrophotometers with the speed of a spectral scanner at a fraction of the price. Whether you are a graphic designer, pre-press specialist or printing press operator, the Spectrocam has been designed to meet your need for fast and accurate color control.

- A great add-on to ICC profiling packages – Link with leading software vendors for color management solutions
- Calibrate your printer, monitor or printing press quickly and accurately
- Meets ISO standards for color measurement
- Includes an ISO black scan plate, scan ruler, monitor calibration unit, white reference target and color measurement software
- Spectrocam software (Windows 95, 98, NT and Mac OS 7.5 or higher) displays spectral measurement values, CIE XYZ, xyY, Luv, Lab, LCH, correlated color temperature, whiteness index, HSB and RGB



TOOLS

PART #	DESCRIPTION
EQP-IHSC	Spectrocam

Functions: Spectrocolorimeter
Spectrodensitometer
Monitor Calibrator
Spectral Camera



See link #T171 for detailed specifications.

QIP Gloss Meters

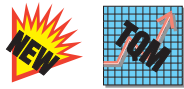

Communicate an exact gloss value to your suppliers, pressmen and customers

This indispensable quality control tool will minimize customer complaints with respect to gloss level appearances, improve productivity, make re-runs a snap and provide a means of repeatability. The GlossMate offers a single, angle-of-measurement geometry while the GlossMaster offers multiple angles. Both models are engineered for consistent linearity, repeatability, automatic calibration and long-term stability. Gloss meters are a necessity if you are running a coating unit or use overprint varnishes.

- Compact, lightweight and portable
- Simple, one-button operation features no warm-up time
- Dual-beam measurement system
- Storage for 400 measurements
- Averaging, Statistical and Pass/Fail functions
- Built-in RS232 interface
- Instantaneous data display
- Auto power-off after three minutes
- Measuring Range: 0.0 to 2,000 Gloss Units (GU), automatic range selection
- Accuracy: ± 1 GU; Reproducibility: 0.5 GU
- Conforms to all gloss standards (ISO, JIS, DIN, ASTM, TAPPI)



See link #T172 for a complete overview of the application of the Glossmeter in the Graphic Arts.



PART #	DESCRIPTION	ANGLE	APPLICATION
EQP-QIPGM60	GlossMate 60	60°	For gloss surfaces in printing, packaging and publishing applications
EQP-QIPGM75	GlossMate 75	75°	For unprinted coated and uncoated papers to ensure gloss levels
EQP-QIPGM206085	GlossMaster 20, 60, 85	20°, 60°, 85°	For high gloss, general printing, and matte surface applications
EQP-QIPGSP	Gloss Spec Plus Software & Cable	N/A	For data feed into computer

X-ACTO



No. 1 Knife

The original graphic arts knife

4 7/8" aluminum handle with No. 11 blade for delicate, precision cutting of lightweight materials like paper, plastic, film and polyester. Includes safety cap. Also available as a set with 15 No. 11 Blades in a dispenser (XAC-5251).



The Gripster

The rubberized barrel assures a firm, comfortable grip for safe and precise cutting. Features anti-roll design and rear blade release. Includes safety cap.



X-Acto 2000

A design winner

This knife has a new innovative design with sleek, ergonomic rubberized barrel for a more comfortable grip, offering superior performance for detailed and precise cutting. Features a unique, anti-roll design and center-barrel blade release. Includes safety cap.

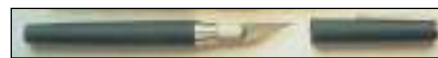

Precision Pen Knife

This sleek, black knife conveniently and safely fits into your pocket so it goes wherever you go. Includes screw safety cap.

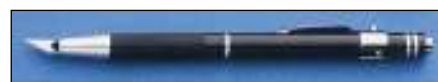

X-Calibre Knife

This compact knife is specially designed for delicate, precision cutting and trimming. Includes push-button, retractable stainless steel blade and convenient pocket clip for portability.



No. 9RX Knife

Retractable push-button knife. Features positive lock when open. Perfect for delicate, close work that requires accuracy.

X-ACTO KNIVES

PART #	DESCRIPTION
XAC-1	No. 1 Knife
XAC-5251	No. 1 Knife w/Dispenser of 15 No. 11 Blades
XAC-GRIP	The Gripster
XAC-2000	X-Acto 2000 Knife
XAC-3	Precision Pen Knife
XAC-3295	X-Calibre Knife
XAC-3209	9RX Knife

X-ACTO BLADES

PICTURE OF BLADE	STYLE	QTY/PKG	PART #	COMPATIBLE KNIFE
	No. 11	5	XAC-11	
	No. 11	15	XAC-411	No. 1, 3,
	No. 11	100	XAC-611	Gripster or 2000
	No. 11	500	XAC-511	
	No. 11 Stainless	100	XAC-621	
	No. 16	5	XAC-16	No. 1, 3,
	No. 16	100	XAC-616	Gripster or 2000
	No. 209	5	XAC-209	No. 9RX
	No. 295	5	XAC-295	X-Calibre RT
	No. 8R	5	XAC-208	Foam Board Cutter
	No. 292	5	XAC-292	Ergo Utility Knife
	No. 492	15	XAC-492	SurGrip Metal Utility Knife
	No. 692	100	XAC-692	



HANDY TIP

Lithco Correct-A-Neg™ opaque pens make perfect indelible markers for writing on CD-ROMS.

Ergo Utility Knife



This uniquely designed knife allows you to do heavy-duty cutting with minimal effort. The blade may be inserted to use as a standard cutter or as a scraper. Available in assorted colors.



SurGrip Metal Utility Knife



This knife is designed for a wide variety of heavy-duty cutting applications and features a retractable blade for safety.



Foam Board Cutter

Versatile and easy to use, this handy cutter makes both 45° and 90° cuts, either right- or left-handed. Great for channel cuts and forming rightangled and rounded corners. Uses standard X-Acto 8R utility blade.



PART #	DESCRIPTION
XAC-3275	Ergo Utility Knife
XAC-3274	SurGrip Metal Utility Knife
XAC-7747	Foam Board Cutter

X-Acto Self-Healing Mats

Protect your work surfaces with these impressive self-healing mats

Ideal for cutting and trimming artwork, film, and much more. Keep one at your desk to protect its surface while cutting. Available in opaque gray and translucent white.



- One inch pattern helps in achieving accurate cuts
- Available in your choice of many convenient sizes from 9" x 12" up to 24" x 36"
- Translucent surface allows light to show through making it perfect for light tables

PART #	COLOR	STYLE	SIZE
XAC-7760	Gray	Opaque	9" x 12"
XAC-7761	Gray	Opaque	12 x 18"
XAC-7762	Gray	Opaque	18" x 24"
XAC-7763	Gray	Opaque	24" x 36"
XAC-7764	White	Translucent	9" x 12"
XAC-7765	White	Translucent	12" x 18"
XAC-7766	White	Translucent	18" x 24"
XAC-7767	White	Translucent	24" x 36"

Bienfang® Foam Board

A lightweight, yet durable media for mounting displays, product presentations, artwork or ink jet plotter output. Two-sided, smooth white surfaces with white foam core. Also available black on black. Boards are 3/16" thick.



Bienfang® MightyCore™ Heavy-Duty Foam Board

Smooth outside...solid inside

MightyCore is one of the strongest, most versatile, heavy-duty foam board products on the market today. Easy to work with and incredibly durable, MightyCore has a smooth, sulfite paper surface. An underlamine moisture barrier of polyethylene prevents bowing and warping. Boards are 1/4" thick. Excellent choice for a wide variety of applications including:

- Mounting photos, digital images and lithos
- Building exhibits
- Point-of-purchase displays and signs
- Screen printing

PART #	SIZE	COLOR	DESCRIPTION
MIS-FB2030	20" x 30"	White on White	Bienfang Foam Board
MIS-FB3040	30" x 40"	White on White	Bienfang Foam Board
MIS-FB2030B	20" x 30"	Black on Black	Bienfang Foam Board
MIS-FB3040B	30" x 40"	Black on Black	Bienfang Foam Board
MIS-MC2030	20" x 30"	White on White	Bienfang MightyCore Foam Board
MIS-MC3040	30" x 40"	White on White	Bienfang MightyCore Foam Board

OLFA

OLFA® CUTTERS

First designed in 1956, OLFA continues to set the standard in durability and design. **THE** premier snap-off knives and blades in the world. Do not accept substitutes...OLFA offers the best. Guaranteed!

STANDARD CUTTERS

Silver Cutter



High quality stainless steel deluxe model is perfect for art, engineering and graphics applications. Sleek design with positive blade slide mechanism. Integrated blade snapper is built right in to handy pocket clip. Another OLFA first.

Auto-Lock SVR-2 Silver Cutter



Features an auto-lock slide mechanism for convenience and safety

This improved, high-quality stainless steel cutter is perfect for a variety of applications. The SVR-2 has a built-in safety blade snapper for rapid blade change and a sleek stainless steel handle. As an extra, the SVR-2 has been modified to better accommodate the needs of both right- and lefthanded users.

"A" Cutter



Professional model made specifically for draftsmen, artists and strippers. The versatile design allows the blade to be inserted either way for a right- or lefthanded user. Integrated blade snapper built into handy pocket clip.

Model 180 Cutter



This economical, multi-purpose knife features a metal liner and is usable in a variety of applications. Integrated blade snapper built into handy pocket dip.

Model NA-1 HandSaver Cutter



The only standard duty cutter of its kind, it features a fully cushioned grip handle for maximum control and comfort. Features a complete stainless steel blade channel for safety and auto-lock slide mechanism. Accommodates all the OLFA "A" size blades.

Model 300 Cutter



This standard cutter features a lock-secured blade and a larger grip.

STANDARD CUTTERS	
PART #	DESCRIPTION
OLF-SIL	Silver Cutter
OLF-SVR2	Auto-Lock Silver Cutter
OLF-A	"A" Cutter
OLF-180	Model 180 Cutter
OLF-NA1	Model NA-1 Cutter
OLF-300	Model 300 Cutter

OLFA REPLACEMENT BLADES

PICTURE OF BLADE	PART #	STYLE
	OLF-AB10 OLF-AB50	Standard
	OLF-ABS10	Stainless Steel
	OLF-BB10 OLF-BB50	ULTRAMAX , Triple Honed
	OLF-A1160B	Art No. 11, Long Tapered Point
	OLF-CTB5 OLF-CTB30	Carton Cutter
	OLF-LB6 OLF-LB50	Heavy Duty
	OLF-LBB10 OLF-LBB50	ULTRAMAX , Triple Honed
	OLF-SKB25	Double Pointed

OLO® Rolling Scissors

Safer than conventional scissors...
no sharp edges



Cuts by rolling instead of squeezing. A specially designed built-in line guide guarantees accurate cuts at any length. Comfortable, useable grip for either right- or left-handed users. Ideal for plastic films, blueprints and large-format ink jet media. Very safe to use.

PART #	DESCRIPTION
MIS-OLO	OLO Rolling Scissors

OLFA Scissors

Designed for the professional, these are no ordinary shears!



Extra-sharp, serrated stainless steel blades resist slipping. Designed for either right or left-handed use. Lightweight ABS plastic handles. Suitable for any and all cutting applications.

PART #	DESCRIPTION
OLF-SCS1	OLFA 5" Scissors
OLF-SCS2	OLFA 7" Scissors



**Snap-Off
Blade Invented
and Introduced
by OLFA!**

QTY/PKG	COMPATIBLE KNIFE
10, 13-Edge Blades 50, 13-Edge Blades	A, Silver, 180, 300, NA-1, SVR-2
10, 13-Edge Blades	A, Silver, 180, 300, NA-1, SVR-2
10, 13-Edge Blades	A, Silver, 180, 300, NA-1, SVR-2
10, 6-Edge Blades	A, Silver, 180, 300, NA-1, SVR-2
5, 6--Edge Blades 30, 6--Edge Blades	A, Silver, 180, 300, NA-1, SVR-2
6, 8--Edge Blades 50, 8-Edge Blades	FL, L-1, L-2, CL, NOL-1, NL-AL, PL-1, CMP-2
10, 8-Edge Blades 50, 8-Edge Blades	FL, L-1, L-2, CL, NOL-1, NL-AL, PL-1, CMP-2
5, 2-Edge Blades	SK-4

Blade Safety Can

One safe location for your dull and worn out blades

High-impact plastic container offers safe disposal of dull AB and LB blade segments. Non-removable lid features blade-snapping slot for easy discard.



PART #	DESCRIPTION
OLF-DC1	Blade Safety Can

HEAVY DUTY CUTTERS

PART #	DESCRIPTION
OLF-FL	Model FL
OLF-L1	Model L-1
OLF-L2	Model L-2
OLF-PL1	PROLOAD Model PL-1
OLF-CL	Model CL
OLF-NOL1	HandSaver Model NOL-1
OLF-NLAL	HandSaver Model NL-AL
OLF-SK4	Model SK-4
OLF-CTN1	Carton Cutter



Did you know OLFA cutters are guaranteed forever?



HEAVY DUTY CUTTERS

Model FL Cutter

This heavy-duty knife allows for one-hand operation with slide-type finger blade lock.



Model L-1 Cutter

Heavy-duty knife for demanding applications with ratchet wheel blade lock and steel shank.



Model L-2 Cutter

Heavy-duty knife features a ratchet wheel blade lock, non-slip rubber grip for added safety and a steel shank.



Model PL-1 **PROLOAD** Cutter **NEW**

This revolutionary cutter easily accommodates the need for a continuous blade change. This cutter accommodates up to six heavy-duty blades per load, for a total of 48 new cutting edges. It also features an auto-lock blade slide, a ratchet blade lock for cutting through difficult materials and a blade storage lock for safety. Perfect for applications requiring multiple or frequent blade changes. Three blades included.



Reverse Side:

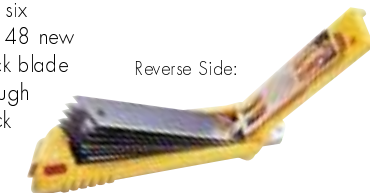

Model CL Cutter

Designed for use in shipping rooms. Additional features include a cutting guide and staple remover.



Model NOL-1 **HandSaver** Cutter

Cushioned grip provides a more positive grip for lasting comfort and safer use. Ratchet wheel blade lock. Includes one blade with eight cutting edges.



Model NL-AL **HandSaver** Cutter **NEW**

Cushioned grip handle reduces hand fatigue and improves comfort. This cutter features an auto-lock blade slide, stainless steel blade channel and rope loop.



Model SK-4 Safety Cutter **NEW**

This safety knife features a heavy-duty blade that automatically self retracts when not in use. Designed for either right or left handed use. Includes double pointed blade.



Carton Cutter

Designed for one purpose only...cutting corrugated cardboard so the job is completed easily and quickly. Snap-off blade retracts into handle as an added safety feature.



Self-Healing Cutting Mats



The highest quality cutting mats available

The OLFA cutting mats are self-healing, professional cutting surfaces especially designed for use with OLFA utility cutters and rotary cutters. Available in green with grid lines or translucent with white grid lines (perfect for use in graphic applications using light boxes). These mats are highly recommended for surface and blade protection. Available in a variety of sizes.

PART #	SIZE	DESCRIPTION
OLF-GCM1218	12" x 18"	Green Cutting Mat
OLF-GCM1824	18" x 24"	Green Cutting Mat
OLF-GCM2436	24" x 36"	Green Cutting Mat
OLF-TCM1218	12" x 18"	Translucent Cutting Mat
OLF-TCM1824	18" x 24"	Translucent Cutting Mat
OLF-TCM2436	24" x 36"	Translucent Cutting Mat

Call about mats up to 23" x 70" in size.

SPECIALTY CUTTERS



RTY-2/DX 45 mm Rotary Cutter

The ergonomically designed cushioned handle provides a comfortable grip.



Features a dual-action safety lock allowing the user to lock the blade open for comfort, closed for safety and can be used right- or left handed. Perfect in all applications where precision cutting is required. OLFA highly recommends the use of an OLFA cutting mat to prolong the life of the blade and for surface protection.

PART #	DESCRIPTION
OLF-RTY2	RTY-2/G 45 mm Rotary Cutter
OLF-RTY2/DX	RTY-2/DX 45 mm Rotary Cutter
OLF-CMP1	CMP-1 Circle Cutter
OLF-CMP2	CMP-2 Compass Cutter
OLF-P450	P-450 Standard-Duty Plastic/Laminate Cutter
OLF-P800	P-800 Heavy-Duty Plastic/Laminate Cutter

All OLFA cutters are guaranteed forever.

PICTURE OF BLADE	PART #	STYLE	QTY/PKG	COMPATIBLE KNIFE
	OLF-RB1	Rotary - 45 mm	1	RTY-2/DX, RTY-2/G
	OLF-RB5	Rotary - 45 mm	5	RTY-2/DX, RTY-2/G
	OLF-COB	Circle Cutter	15	CMP-1
	OLF-PB450	Standard-Duty Plastic/Laminate	3	P-450
	OLF-PB800	Heavy-Duty Plastic/Laminate	3	P-800

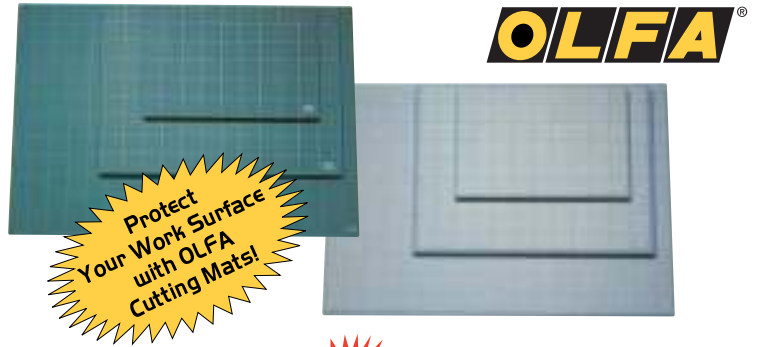

CMP-1 Circle Cutter



Standard-duty circle cutter. Perfect for use on paper, films, cardboard and lighter wood cutting requirements. Cuts circles up to 6" in diameter.



CMP-2 Compass Cutter



Heavy-duty compass cutter is designed to cut circles from approximately 3" to 12" diameter. Easily adjusts to accommodate users requirements.



RTY-2/G 45 mm Rotary Cutter



Introduced by OLFA in 1979, the 45 mm rotary cutter features a blade safety cover and the handle is designed to reduce hand fatigue. The cutter is a rolling razor blade used to cut a variety of materials into shapes, strips and pieces. Accommodates both right- and left-handed users. OLFA highly recommends the use of an OLFA cutting mat to prolong the life of the blade and for surface protection.



P-450 Standard-Duty Plastic/Laminate Cutter



P-800 Heavy-Duty Plastic/Laminate Cutter

Ideal for sign shops

Plastic/laminate cutter is designed as a scoring tool for lightweight sheet plastics and laminates. Features a tungsten blade with two replacement blades in the handle. Heavy-duty plastic/laminate cutter features a reversible tungsten blade. Produces a very fine score line allowing for the precise breaking of plastics.



Don't see what you are looking for? The entire range of OLFA products is available from Lithco.

RAZOR BLADES, SCRIBES & PASTE-UP TOOLS



Ramsey Film Line Cutters

Ramsey Film Line cutters deliver firm, clean cut lines in film emulsion, leaving sharp edges for perfect reproduction. Sold in two-packs or in convenient variety packs.

- Made of the finest spring steel
- Different colored handles make line width identification fast and easy
- Available in five different line widths

PART #	CUTTER	LINE WIDTH
MIS-RAM1	#1 Blue	.040"
MIS-RAM2	#2 Red	.025"
MIS-RAM3	#3 Yellow	.012"
MIS-RAM4	#4 Gray	.009"
MIS-RAM5	#5 Green	.005"

RAMSEY FILM LINE CUTTER variety packs		
PART #	SET	DESCRIPTION
MIS-RAMA	#A	3 cutters, 1 each #1, #2, #3
MIS-RAMB	#B	3 cutters, 1 each #3, #4, #5
MIS-RAMC	#C	5 cutters, 1 each #1, #2, #3, #4, #5

Did you know...



Lithco now offers an assortment of table-top bindery equipment for small to medium size shops. See pages 92-95, 102-103.



Lithco Single Edge Razor Blades

The highest quality, sharpest edge available

Made to fit all standard razor blade tools. Safety backing allows hand-held use for precise, fingertip control. Each blade individually wrapped, packed 100 blades per dispenser box. Available as #9 Commercial Grade, or #12 Premium Grade made with a sharper edge and designed for longer life. Made in the USA.

PART #	DESCRIPTION
RAZ-9	#9 Commercial
RAZ-12	#12 Premium



Litho Needles

Round needle in varnished hardwood handle. Designed specifically for etchers, finishers, lithographers, map making, dot raising and stippling. Available in eight sizes.

PART #	SIZE
MIS-LN00	00
MIS-LN0	0
MIS-LN1	1
MIS-LN2	2
MIS-LN3	3
MIS-LN4	4
MIS-LN5	5
MIS-LN6	6

Paste-Up Tools



Every tool you need for paste-up work

Kit contains precision tweezers, aluminum knife-handle with blades and two stylus/burnishers. Ideal for layout, signmaking and scrapbooking. The stylus/burnisher and pin-vise are available separately.

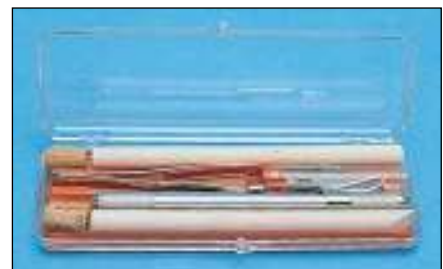

PART #	DESCRIPTION
MIS-PUK	Paste-Up Kit
MIS-SB	Stylus-Burnisher – Set of 6
MIS-PV	Pin-Vise with 1 Pin
MIS-PVR	Replacement Pins – Set of 12

GAEBEL RULERS

GAEBEL RULERS

Arthur H. Gaebel, Inc., "The Original" Ruler Company is proud to have celebrated more than fifty years as a family owned and operated business, dedicated to filling your most demanding graphic arts requirements. Lithco has chosen to partner with Arthur H. Gaebel, manufacturer of the finest rulers available.



Line Gauges

Made from stainless steel, these high quality line gauges feature engraved graduations and markings for long-lasting accuracy and easy identification. Corrosion-resistant to withstand harsh working environments. Available in a wide variety of popular styles, lengths, and markings including points, picas, inches, agate and metric.

PART #	STYLE	LENGTH	PART #	STYLE	LENGTH
LIT-L61212	612	12"	LIT-L612F24	612F	24"
LIT-L61218	612	18"	LIT-L612H12	612H	12"
LIT-L61224	612	24"	LIT-L612H18	612H	18"
LIT-L612E12	612E	12"	LIT-L612H24	612H	24"
LIT-L612F12	612F	12"	LIT-L611C6	611C*	6"
LIT-L612F18	612F	18"			



*Includes pocket clip.

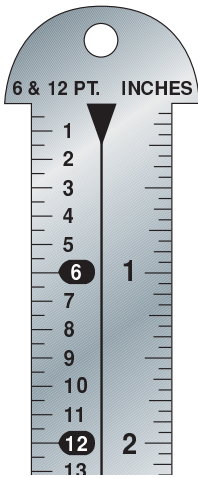

L612 FRONT

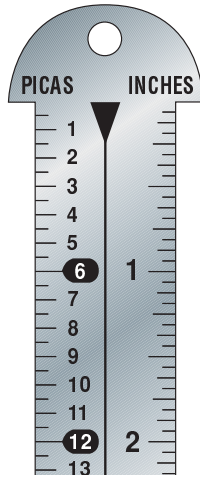

L612E FRONT

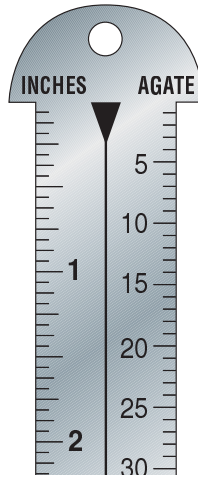

L612F FRONT

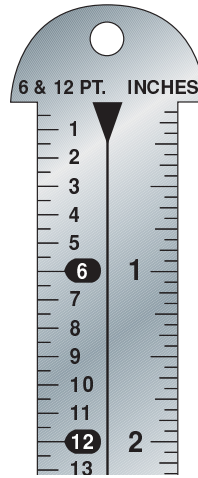

L612H FRONT

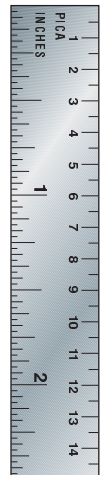

L611C FRONT

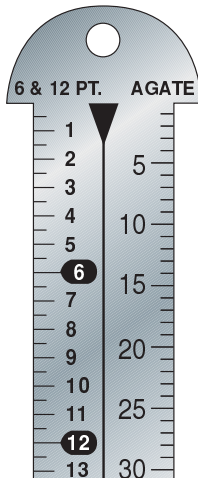

L612 BACK

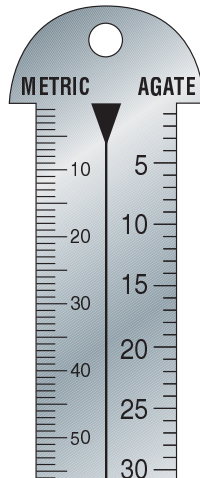

L612E BACK

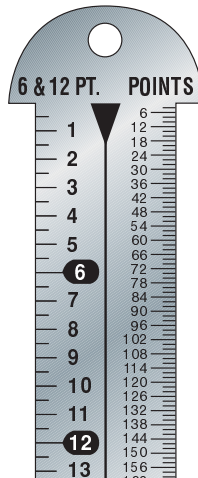

L612F BACK

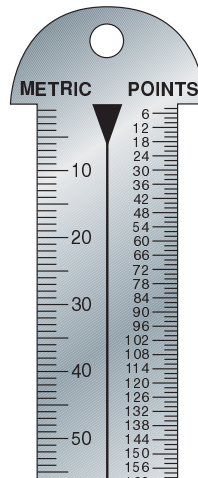

L612H BACK

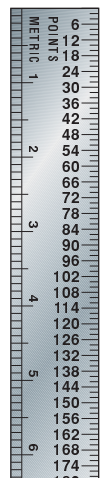

L611C BACK

Stainless Steel Printers' Rulers

Engraved graduations and markings for improved accuracy, time and time again. Corrosion-resistant for durability and long life. Available in four popular lengths and a wide variety of markings including points, picas, agates, inches and metric. Both the start and finish of these rulers are indented.

PART #	STYLE	LENGTH
LIT-L60424	604	24"
LIT-L60436	604	36"
LIT-L604C24	604C	24"
LIT-L62412	624	12"
LIT-L62418	624	18"
LIT-L62424	624	24"

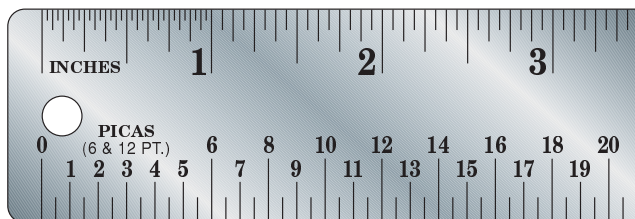

STYLE L624 FRONT

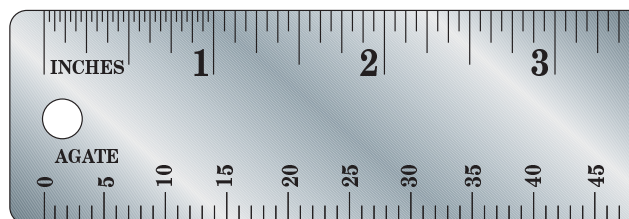

STYLE L624 BACK

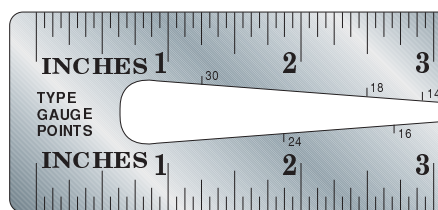

STYLE L604 FRONT

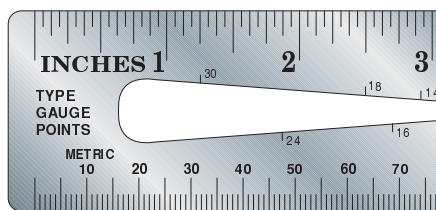

STYLE L604C FRONT

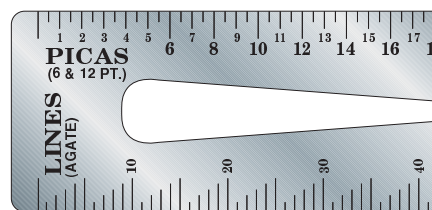

STYLE L604 & L604C BACK

Stainless Steel Cork-Backed Rulers



Etched graduations and markings ensure long-life and scale accuracy. The cork backing prevents the ruler from moving during measurements or sliding off slanted drafting tables. The start and finish of the scales are indented from the ends, in both inch and metric scales.

PART #	STYLE	LENGTH
LIT-L20012	200	12"
LIT-L20018	200	18"
LIT-L20024	200	24"

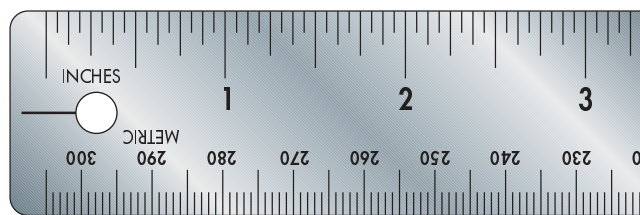

STYLE L200 FRONT



If you are having static and dust control problems in your Prepress department, see pages 47 – 49 and 117 for solutions.

Stainless Steel Zero-Center Ruler



A fully zero-centered ruler with engraved markings indented from the ends. The front is zero-centered with picas on the top and 10ths on the bottom. The back is also zero-centered with inches in 16ths on the top and 12ths on the bottom.

PART #	STYLE	LENGTH
LIT-L62724	627	24"
LIT-L62736	627	36"

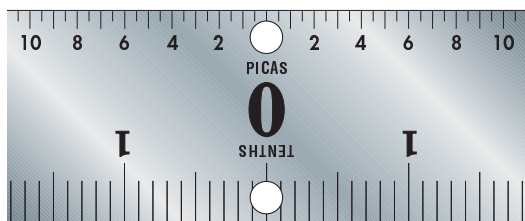

STYLE L627 FRONT

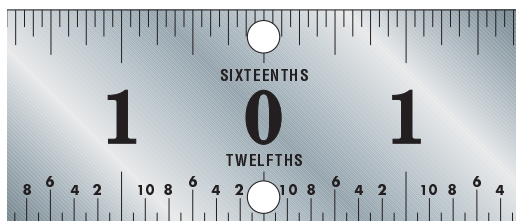

STYLE L627 BACK

T-SQUARES, TRIANGLES & SAFETY RULERS



Stainless Steel T-squares

These T-squares feature a stainless steel blade, beveled edges for inking, and a cast aluminum head. Available in three lengths.

PART #	LENGTH
LIT-TS24	24"
LIT-TS36	36"
LIT-TS48	48"

Stainless Steel Triangles - Economy & Professional

Solid stainless steel construction guarantees durability and corrosion resistance. Triangles have a reversible knob enabling either right- or left-handed use. Knob on Economy Grade is plastic, Professional grade is steel. Two styles available: 30°/60°/90° or 45°/45°/90°.

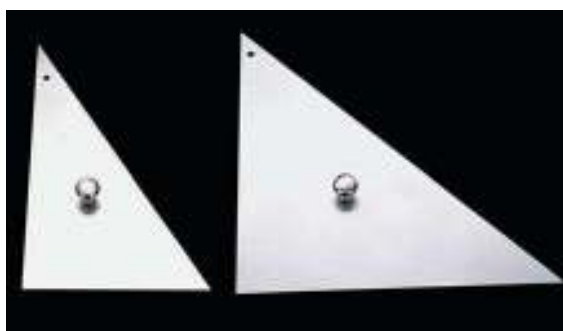

PART #	ANGLES	LENGTH
Economy Triangles - 0.050" thick		
LIT-L5828	30°/60°/90°	8"
LIT-L5838	45°/45°/90°	8"
LIT-L58210	30°/60°/90°	10"
LIT-L58310	45°/45°/90°	10"
LIT-L58212	30°/60°/90°	12"
LIT-L58312	45°/45°/90°	12"
LIT-L58215	30°/60°/90°	15"
LIT-L58315	45°/45°/90°	15"
LIT-L58218	30°/60°/90°	18"
LIT-L68318	45°/45°/90°	18"
Professional Triangles - 0.080" thick		
LIT-L6828	30°/60°/90°	8"
LIT-L6838	45°/45°/90°	8"
LIT-L68210	30°/60°/90°	10"
LIT-L68310	45°/45°/90°	10"
LIT-L68212	30°/60°/90°	12"
LIT-L68312	45°/45°/90°	12"
LIT-L68215	30°/60°/90°	15"
LIT-L68315	45°/45°/90°	15"
LIT-L68218	30°/60°/90°	18"
LIT-L68318	45°/45°/90°	18"

Lithco Safety Ruler & Lithco Pro Safety Ruler

Provides an extra margin of safety during hand-trimming operations



The Safety Ruler is a combination ruler/straight edge. A curved aluminum guard prevents your knife from accidentally cutting your fingers. Space age technology produces a laser-straight cutting edge. Ideal for sign making and large format digital imaging.

- Solid aluminum alloy body features an extra-thick cutting face
- Extra-wide 2.6" ruler gives a generous 2" comfort grip
- Hand easily fits inside the gently curved finger guard
- Non-slip rubber gripper material on back side
- Unique transparent sliding marker moves along the ruler scale
- Steel measuring scale extends out to measure objects longer than the ruler
- Scale is solvent-proof and graduated in 1/16" increments
- Built-in handle for easy pick-up
- Pro Safety Ruler features a hardened stainless steel cutting face for durability and a superior non-slip backing

HANDY TIP

Olfa cutters make the perfect companion to our Safety Rulers. See pages 20 - 22.

SAFETY RULER PART #	PRO RULER PART #	LENGTH
LIT-SR28	LIT-PSR28	28"
LIT-SR40	LIT-PSR40	40"
LIT-SR52	LIT-PSR52	52"
LIT-SR64	LIT-PSR64	64"
LIT-SR76	LIT-PSR76	76"
LIT-SR100	LIT-PSR100	100"



Lithco Screen Angle and Line Determiner



Check screen angles and line ruling in one, quick easy step

This handy measuring device will quickly and accurately determine both the line and angle of each color. Place the Lithco Screen Angle and Line Determiner on an offset print and a series of concentric circles appears. The lines that intersect these circles will indicate the angles and line of the screen(s) used. Ever need to quickly determine which separation negative you were stripping? If used on a single separation film, only one circle will appear, indicating your negative.

- Works on film or printed item
- Measures angles from 0° to 105°
- Measures line rulings from 85 to 200 LPI
- Double-laminated for durability



DOMINANT CIRCULAR MOIRÉ PATTERN INDICATES 150L, 75° ANGLE

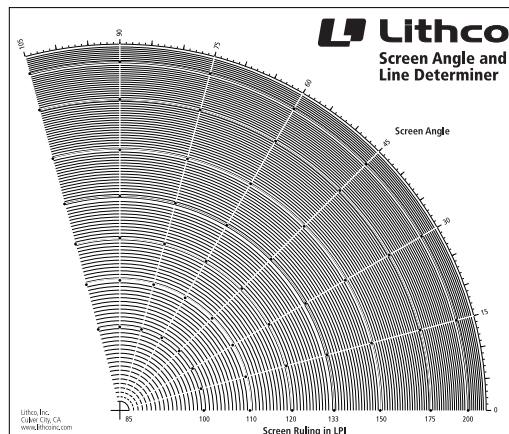

Place the Lithco Screen Angle and Line Determiner on an offset print and a series of concentric circles appears. The lines that intersect these circles will indicate the angle and line of the screen(s) used. If used on a single separation film, only one circle will appear, indicating your negative.

PART #	DESCRIPTION
LIT-SALD	Screen Angle and Line Determiner

C-THRU RULERS

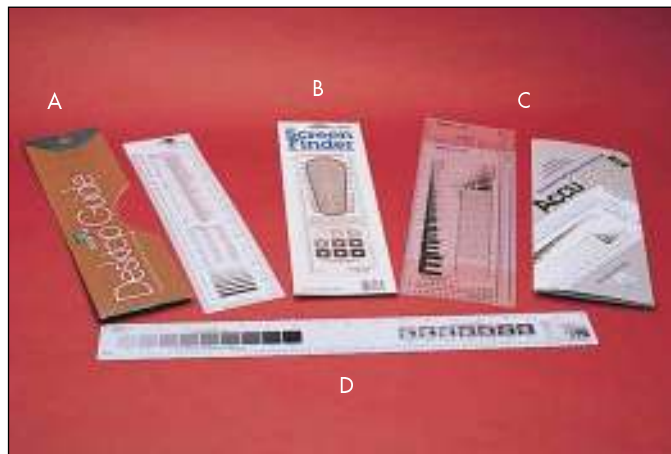

Accuspec II

The professional's choice for fast and accurate layout, design and type specification

Accurate, fine calibrations and a non-glare matte finish. Flexible and transparent for easier measurement. Actual size 4 1/2" x 12 3/8". Features the following scales on two separate rulers:

- Agate and point size scale
- E-Scale & leading gauge
- Type size gauge from 6 to 13 and 15 point
- Line rules, bullets and squares from hairline to 16 point

PART #	DESCRIPTION
MIS-CTGS1	Desktop Guide (A)
MIS-CTSFG1	Screen Finder Guide (B)
MIS-CTAS2	Accuspec II (C)
MIS-CTGA86	Graphic Arts Ruler (D)

Screen Finder Guide

A necessity for every graphic artist, printer and advertising agency

Place the compact 3" x 9 3/4" guide over a halftone or tinted area and the "moiré star" points to the line ruling, from 50 lines/inch to 200 lines/inch. Also contains:

- Color density guide in 10% increments
- Pica and inch scales

Desktop Guide for Macintosh®

Versatile guide is just about as handy as your mouse

Keep this transparent two-guide set at your workstation for quick and easy access to valuable information you use daily. It includes:

- Inch, metric, point scales and E-scale
- Conversion scale of fraction of an inch to decimal, inch to metric (mm)
- International paper sizes, commercial envelope chart
- Macintosh Key Cap Guide

Graphic Arts Ruler

This special ruler displays more than just measurements!

Laminated, opaque white plastic printed on both sides. This 18" ruler is calibrated in Inches, Picas, Agates and Point sizes.

- Inch scale has "zero center"
- Square and bullet point sizes
- E-Scale and line rule
- Proofreader's marks
- Color density screen guide and halftone screens

GAUGES & GUIDES



MIKE-EZ™

The fastest, easiest pocket tool for measuring sheet goods

This is the latest in thickness gauges.

Based on the old concept of a "go-no-go"

gauge, this compact unit easily fits in your pocket so it is always there when you need it.

Estimating, production, sales and quality control are just a few of the areas where Mike-EZ saves you time and makes your job a little easier.

- Mike-EZ is precision machined from aerospace grade aluminum
- Has a durable anodized finish
- Accurate to 0.001"
- Color-coded models for quick identification
- Inch and metric models
- Range from 0.004" to 0.016"



Manufactured by Plexus Pacific Industries Mike EZ comes with an unconditional lifetime warranty. You break it, they fix it.

PART #	DESCRIPTION	RULING	RANGE	INCREMENT
MIS-MESP	Mike EZ	Inch	.004" to .016"	0.001"
MIS-MEMP	Mike EZ	Metric	.1 to .4 mm	0.1 mm
MIS-QM	Quick Mini	Both	0 to 0.5"	0.0005"
			0 to 12.7 mm	0.01 mm

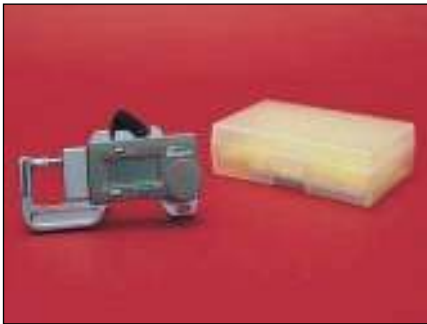

Quick Mini Digital Thickness Gauge

It's fast...It's easy...It's accurate!

The Quick Mini is a fast, yet accurate way to check thickness and simple dimensions with ease.

- Large, easy to read LCD display
- Measurements in either inch or metric formats
- One-hand operation



HANDY TIP

Use a spring-loaded thickness gauge for measuring soft materials such as paper, film and blankets. Use a standard Swiss-style micrometer on hard materials only.

The PRINTMATE®

The ultimate, single-source, multipurpose printer's guide

This handy tool will assist you when selling value added services and training your staff and clients. Its overall size of 20" x 26" allows you to use it as a counter mat or a wall poster. Contains over fifty of the top functions needed to explain, check and sell many aspects of the printing industry. Printed on clear, durable plastic.

PART #	DESCRIPTION
MIS-PM	PRINTMATE

MICROMETERS & THICKNESS GAUGES

Pocket Thickness Gauge

A necessity in every plant

An economical pocket gauge for measuring the thickness of paper, polyester stripping film, press packing sheets and offset blankets.

- Hardened steel spindle
- Quick, easy zero adjustment
- Corrosion-resistant, lightweight frame
- Available in inch or metric scale
- Includes hard-shell storage case
- Optional leather pouch also available

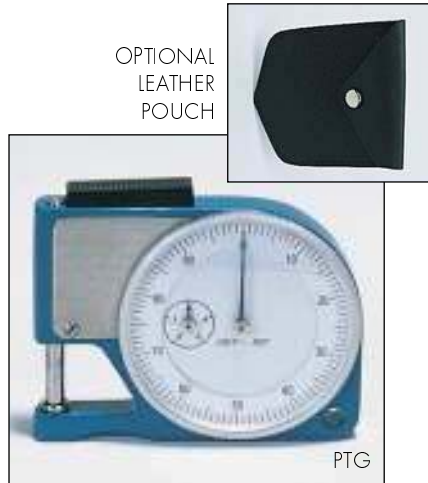

Micrometer

Ideal for measuring hard-surfaced materials

This popular, economical, Swiss-style micrometer is designed to give quick, accurate readings.

- Measures to 1.0" in 0.001" increments
- Ratchet thimble assures consistent readings
- Barrel and thimble are satin-chrome finished
- Carbide tipped measuring faces for long life, added accuracy
- Wrench included for easy zero adjustments

Digital Pocket Thickness Gauge

No more "reading between the lines"

This simple-to-use thickness gauge is completely portable, lightweight and displays a digital reading.

- Reads both inches and metric at the touch of a button
- Bright 3/8" x 1 3/4" LCD display
- Automatic shut-off extends battery life
- Protective, cushioned hard-shell storage case



Dial Thickness Gauge

This well designed and constructed thickness gauge has all the features of the pocket thickness gauge, but features a large frame that is ideal for bench use. Available in inch or metric scale.

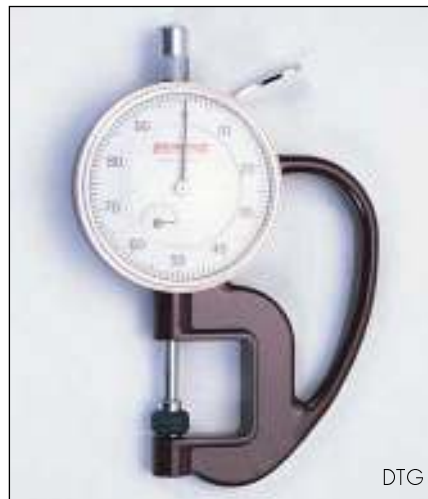

Ames Pocket Thickness Gauges

The perfect precision instrument for gauging compressible items.

- Frame is precision cast, aluminum alloy
- Contoured to comfortably fit in your hand
- Easy zero-resetting
- Protective leather carry pouch for convenient storage

MICROMETERS				
PART #	DESCRIPTION	RULING	RANGE	INCREMENT
MIS-MICRO	Micrometer	Inch	0 to 1"	0.001"
MIS-PTG	Pocket Thickness Gauge	Inch	0 to 0.5"	0.001"
MIS-PTGM	Pocket Thickness Gauge	Metric	0 to 10 mm	0.01 mm
MIS-PTGP	Pocket Thickness Gauge Pouch	—	—	—
MIS-DTG	Dial Thickness Gauge	Inch	0 to 0.5"	0.001"
MIS-DTGM	Dial Thickness Gauge	Metric	0 to 10 mm	0.01 mm
MIS-AMES25	Ames Pocket Thickness Gauge	Inch	0 to 0.312"	0.001"
MIS-AMES251	Ames Pocket Thickness Gauge	Inch	0 to 0.312"	0.0005"
MIS-PTGD	Digital Pocket Thickness Gauge	Both	0 to 0.6" 0 to 15.5 mm	0.001" mm 0.01 mm

HANDY TIP

The only accurate way to check packing on a press is with a Trupak Blanket Packing Gauge. See page 70.

GUIDES & SCALES



Color Selector Wheel™

Dial in CMYK values and quickly view the result before proofing or printing

This compact color wheel is the perfect tool for printers, graphic designers, ad agencies, color separators, sales people and students. Easy to use, any combination of process colors can be dialed in to replicate any of 40,000 possible hues in 133 line screen.

- Four transparent disks printed in 10% screen increments from 0% to 100% (solid) in process yellow, cyan, magenta and black
- Compact, easy to carry - only 6½" in diameter
- Economical

PART #	DESCRIPTION
MIS-PCW133	Color Selector Wheel

AlignMate®

The precision of a T-square in a fraction of the effort and time

This timesaving tool is used to check the straightness and centering of printed copy and artwork. Overall size is 8½" x 6". A 16 line per inch grid is perfect for checking all jobs up to 11" x 14".

- Fast, accurate and easy to use
- Unique "C" fold accepts thicker stock
- Use as part of a Total Quality Management Plan

PART #	DESCRIPTION
MIS-AM	AlignMate



Lithco Proportion Wheels

A critical tool, valuable for every camera room, designer and graphic artist

Easy to handle, it quickly and accurately gives you the percentage enlargement or reduction required to scale your original to a new size.

- Easy reading black scale
- Made of heavy gauge vinyl



PART #	DESCRIPTION
LIT-PS	Paper Scale



PART #	DESCRIPTION
LIT-PW	6" Diameter, Inch
LIT-PW8	8" Diameter, Inch
LIT-PWM	6" Diameter, Metric

Lithco Paper Scale

This unique tool directly indicates the weight-basis of a sheet of paper

Easy to read, this scale differentiates between bond, book and cover stock. Simply hang an 8½" x 11" sheet of paper from the clip and the pointer indicates the paper weight. Sold in a handy carry pouch with instructions for use.

WeighMaster Paper Scale



Determine actual paper weight, not thickness, with this unique pocket-sized scale

Determining basis weight for paper has always been a problem because different grades of paper have different sizes for their standard. Often, two different sheets of paper can have the same thickness, but a different weight. The WeighMaster actually weighs a sheet of 8½" x 11" paper, then by using a simple conversion factor specific to the grade of paper, gives the paper's weight. This is much easier than weighing a ream of parent sheets.



- Accurate enough to measure the effect of heavily inked samples
- Applicable to either US/Canadian system or metric
- Provided with the six conversion factors for different paper grades
- Easy-to-read LCD display
- Automatic shut-off saves batteries
- Comes with vinyl carry pouch and batteries
- Limited 180 day warranty

PART #	DESCRIPTION
MIS-WM	WeighMaster Paper Scale

 Visit our web site for more information on paper weight basis. Link #T301

Martin Yale Heavy-Duty Precision Trimmers



Premier®

Super hardened steel blades sharpen themselves with every cut

- ▶ High quality, heavy-duty trimmer available in six different sizes
- ▶ Use to cut paper, film, tissue, cardboard and more
- ▶ Cuts up to fifteen sheets of 20# bond at a time
- ▶ Safety features include finger guard, safety blade brake and patented trigger-style blade latch
- ▶ Precision lifetime measurement grid with English and metric scales
- ▶ Adjustable paper guide simplifies aligning repeated cuts
- ▶ 36-inch model includes automatic paper clamp
- ▶ Wooden base

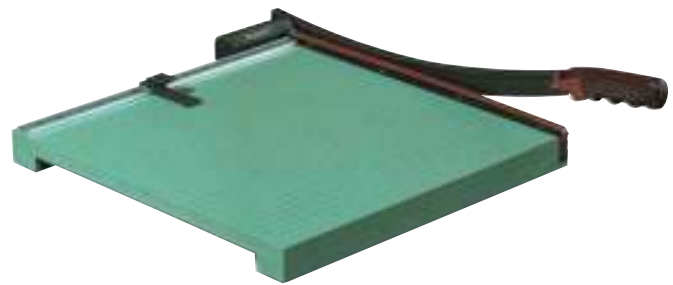

PART #	MODEL	DIMENSIONS	WEIGHT	DESCRIPTION
EQP-MYW12	W12	16" x 22" x 5"	8 lb.	12" Heavy-Duty Precision Trimmer
EQP-MYW15	W15	19" x 27" x 5"	11 lb.	15" Heavy-Duty Precision Trimmer
EQP-MYW18	W18	22" x 30" x 5"	16 lb.	18" Heavy-Duty Precision Trimmer
EQP-MYW24	W24	28" x 36" x 5"	27 lb.	24" Heavy-Duty Precision Trimmer
EQP-MYW30	W30	35" x 41" x 7"	38 lb.	30" Heavy-Duty Precision Trimmer
EQP-MYWC36	WC36	34" x 50" x 7"	58 lb.	36" Heavy-Duty Precision Trimmer



HANDY TIP

Other Premier products from Martin Yale are also available including Rotary Trimmers, PolyBoard™ Trimmers, and StakCut™ Trimmers.

RotaTrim Professional Series Rotary Cutters (formerly Mastercut II)



Allows clean, accurate cuts in film, paper and Silvermaster printing plates

- ▶ Excellent all-purpose cutter for studio, lab and prepress applications
- ▶ Cuts the thinnest tissue to mount boards up to 3 mm thick
- ▶ Long-life, self-sharpening, hollow-ground Sheffield Tungsten Steel cutting blade, totally enclosed in safety housing
- ▶ Die-cast end supports for added strength
- ▶ Clear, plastic clamping strip with cut guides automatically holds material in place
- ▶ Double steel tube suspension for unsurpassed precision with every cut
- ▶ Extruded aluminum squaring bar calibrated for inch and metric readings
- ▶ Stay-clean, high-pressure laminated baseboard
- ▶ **Guaranteed for five years,** excluding blade, for defects in materials and workmanship

PART #	MAX. CUT	DESCRIPTION
EQP-RT12	12"	Rotatrim Professional - 12
EQP-RT15	15"	Rotatrim Professional - 15
EQP-RT17	17½"	Rotatrim Professional - 17
EQP-RT24	24"	Rotatrim Professional - 24
EQP-RT30	30"	Rotatrim Professional - 30
EQP-RT36	36"	Rotatrim Professional - 36
EQP-RT42	42"	Rotatrim Professional - 42
EQP-RT54	54"	Rotatrim Professional - 54

RotaTrim

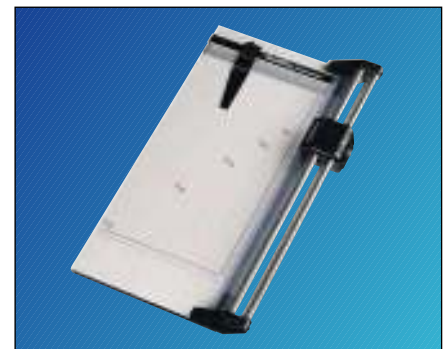

Lithco now offers an entire range of Ink Jet papers under the LithcoJET brand name. Media available for desktop and wide format - comp, proofing and display applications. See pages 38 - 39.

X-Acto Paper Trimmers



Heavy-duty trimmers are indispensable for a wide range of applications.

- ▶ Conventional guillotine blade
- ▶ Wooden base with inch grids for accurate cuts
- ▶ Squaring bar for repeatable cuts
- ▶ Available in four sizes



PART #	SIZE	DESCRIPTION
XAC-T2612	12"	Heavy-Duty Paper Trimmer
XAC-T2615	15"	Heavy-Duty Paper Trimmer
XAC-2618	18"	Heavy-Duty Paper Trimmer
XAC-2624	24"	Heavy-Duty Paper Trimmer

WAXERS & ADHESIVES



Pyrawaxer

Built-in electronic thermostat for precision temperature control

Heavy-duty plastic housing is virtually unbreakable under normal use. Rubber tires guide knurled aluminum roller. Wax level viewing window in housing. Comes with drip-proof stand, 10 oz. box of Pyrawax 2385 and a wooden burnisher/pica ruler.

PART #	MODEL	WIDTH	ON/OFF SWITCH	READY-TIME	READY INDICATOR LIGHTS
MIS-PW288	288	1½"	No	20 Minutes	No
MIS-PW378	378	3"	Yes	30 Minutes	No
MIS-PW388	388	3"	Yes	30 Minutes	Yes

Pyrawax 2385

Faster, neater and more economical than rubber cement



Made for use with all electronic hand waxers. Packaged 144 small cubes/10 oz. box.

- Dries immediately, yet always repositionable
- Will not yellow copy, dry out, or photograph



UHU® stic Glue Stick

Glides smoother, lasts longer than other brands

These compact and handy glue sticks are perfect for quick paste-ups, rubber stampers and ad agency product mockups.

- Screw cap resists drying out
- Washable and nontoxic

PART #	DESCRIPTION	SIZE
MIS-U26	Small Glue Stick	0.28 oz.
MIS-U75	Large Glue Stick	0.74 oz.

Pyrawax 2388



Made specifically for all automatic, tabletop wax coaters. Extra adhesive for better sticking qualities. Melts at a lower temperature, so less energy is required for continuous operation. Will not yellow copy or photograph. Never dries out – always remains tacky. Individually wrapped 3" x 5" bars for easy handling. Packaged 50 bars/10 lb. box. Not recommended for use in hand waxers.

PART #	DESCRIPTION
MIS-PW2385	Use with All Hand Waxers
MIS-PW2388	Use with Table-top Wax Coaters



Brayer

4" roller spreads ink evenly and smoothes out paper. Ideal for block printing, photo-mounting and paste-ups.

PART #	DESCRIPTION
XAC-4128	Brayer

Jiffy Adhesive Wax Sticks



Perfect for all paste-up work

This no-heat-required wax stick is always ready to use.

- Non-hazardous – made from all natural ingredients
- Never dries – copy is repositionable
- Economical to use
- Safe and neat



PART #	DESCRIPTION
MIS-JWS	Jiffy Adhesive Wax Stick



3M™ Super 77 Adhesive

Easy to use and works fast. This adhesive is ideal for many applications where complete coverage is desired as with vellum, layout and grid paper. It has a fast, aggressive tack, yet resists soaking while offering lasting holding power.

3M Scotch™ Spray Mount

Excellent for positioning many lightweight materials on layouts, paste-ups and more. Will not wrinkle, stain or bleed through thin paper. Ideal for mounting newsprint and other delicate papers.

3M Scotch Photo Mount™ Spray Adhesive

Will not damage prints

This clean, non-staining spray is perfect for mounting photos and prints. Resists heat and moisture for a strong, dependable bond.

PART #	SIZE	DESCRIPTION
3M-S77	16½ oz.	Super 77 Adhesive
3M-6065	10¼ oz.	Scotch Spray Mount
3M-6094	15 oz.	Scotch Photo Mount



MORE ADHESIVE PRODUCTS AVAILABLE FROM LITHCO

Best Test Rubber Cement.....page 66

Sprayway Spray Adhesives.....page 66

LectroStik™ Power 600XT™ Waxer

Heats-up in minutes and cleans-up in seconds

Unbreakable glass-fortified lexan body is designed to withstand heat and resist marring. Transparent body allows easy wax level monitoring. Patented, solid-state engineering ensures reliable and precise heat control. Rolls a 1½" wax coating.



LectroStik Wax

One coat coverage does the job

High temperature, non-toxic wax for use with LectroStik and all other hand waxers. Holds longer and re-positions easier. Packaged 60 cubes per 10 oz. box.



PART #	DESCRIPTION
MIS-LS600XT	LectroStik Power 600XT Waxer
MIS-LS601	LectroStik Wax

StikkiSTUFF Assortment



The best products we have seen to keep track of those "can't lose" action notes we all write every day...and then misplace!

StikkiCLIPS are the best way to hang papers anywhere. Their unique adhesive sticks to any surface. StikkiHOOKS and clips are removable and reusable again and again. Great for notes, schedules, job tickets, special instructions and reminders. Call attention to papers **exactly** where they are needed.

- Holds several pieces of paper
- Safe on most surfaces
- Non-magnetic so they are safe for computers

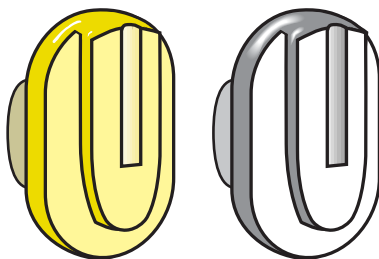

PART #	DESCRIPTION
MIS-SKA	StikkiStuff – Assortment
MIS-SKW20	StikkiCLIPS, White – 20/package
MIS-SKY20	StikkiCLIPS, Neon Yellow – 20/package

VIEWING & POCKET PAL

PANTONE® Color Viewing Light

Perfect when critical color matching is required

These high quality-viewing booths provide artificial daylight, store light and incandescent home light sources under which critical color matches can be checked.

The five light unit adds two additional light sources: north sky daylight for visual color matching, and ultraviolet for text or paper industries to simulate optical brightness, whitening agents and fluorescent pigments. *Some assembly required.*



PART #	DESCRIPTION	LIGHT SOURCES	DIMENSIONS
EQP-PANCVL	3-Light Unit	Artificial daylight, store light, incandescent	28" W x 16½" D x 18" H
EQP-PANCVL5	5-Light Unit	Artificial daylight, north sky daylight, store light, incandescent, UV	28" W x 16½" D x 20" H

Porta-Trace® Light Boxes

The best light box on the market!

Porta-Trace light boxes virtually eliminate the "hot spots" found in other units. The redesigned frames and reflectors, combined with the thick Plexiglas top, provide uniform and even light over the entire viewing surface. Glass top (not included) can be placed over top for cutting by utilizing auxiliary clips (stainless steel models only).



- 5000°K color corrected fluorescent lamps
- 304-stainless steel frame for durability
- UL listed, grounded power cord
- Tiltup leg standard on Models 1012, 1118 and 1618, optional on Model 1824

PART #	MODEL	SIZE	DESCRIPTION
MIS-PT10122C	1012-2C	10" x 12"	Porta-Trace with 2, 8 watt 5000°K bulbs
MIS-PT11182C	1118-2C	11" x 18"	Porta-Trace with 2, 15 watt 5000°K bulbs
MIS-PT16183C	1618-3C	16" x 18"	Porta-Trace with 3, 15 watt 5000°K bulbs
MIS-PT18243C	1824-3C	18" x 24"	Porta-Trace with 3, 20 watt 5000°K bulbs
MIS-PTGTC	N/A	N/A	Glass-top Clips – all stainless models

Other sizes are available from 6" x 18" to 36" x 48". Standard daylight-lamp units are also available. Options include: metal carrying handles for Models 1012 and 1118, vinyl carrying case for Model 1012, Slide/Negative Sorters and solid oak frame light boxes.

Pocket Pal



It's like having a Ph.D. in Graphic Arts in your pocket

This is the ultimate guide to graphic arts production. Since its debut in 1934, graphic artists, designers, publishers, advertising agencies, students and professionals have relied on the *Pocket Pal* as a primary reference source. Each new edition incorporates the latest in technological advances in the industry. The latest edition emphasizes the many changes resulting from an increasing use and application of electronics and computers. Just some of the featured topics include:

- *Typography*
- *Platemaking*
- *Art preparation*
- *Color Management*
- *Electronic prepress systems*
- *Printing processes*
- *Film assembly*
- *Glossary of graphic arts terminology*
- *Printing and the Internet*
- *Paper*
- *Ink*
- *Toners*
- *Binding*

Now there is an essential supplement to Pocket Pal, available on video or DVD, featuring visual presentations of digital printing and other processes detailed in the book.



PART #	DESCRIPTION
MIS-PPAL	<i>Pocket Pal, 18th Edition</i>
MIS-PPALV	<i>Pocket Pal Video Supplement</i>
MIS-PPALDVD	<i>Pocket Pal DVD Supplement</i>

StaffingTools.com
e-assessment, learning and staffing services



Check-out This Special Offer!
Lithco On-Line University



\$289

Get any Digital Media title for \$99.95, or experience the future with Lithco's new On-Line University powered by StaffingTools.com*. Get ALL of these courses, upgrades and all new Digital Media courses for one year on-line, all at one incredible price of just \$289.00. Go to our web site now at www.lithcoinc.com and click on link #D351 to sign up for this terrific program or to experience a FREE demo.

*StaffingTools.com is the exclusive provider of the on-line imaging certification examinations for the National Council for Skills Standards.

PART #	DESCRIPTION
DIG-401000	Lithco On-Line University One Year Subscription

"I've reviewed a lot of interactive training titles for Quark products and others, and your courses are among the best I've seen in the industry. The training is practical and targeted, and the interface is professionally designed."

— Gary Fluit, Former Manager of Interactive Education, Quark Inc.

IdentafONT

It does for type what PANTONE® does for ink!

IdentafONT is a uniquely organized, primary utility for identifying PostScript Fonts. It is a reference set of four books for shelf display (total of 828 pages) divided into four categories: Serif, Sans Serif, Script and Display. To locate a type face, simply scan a maximum of eight pages which are grouped by letter, hence eliminating hours of searching through numerous type books and catalogs.



- Easy access to numerous type faces
- Organized to improve your efficiency
- A valuable design tool

PART #	DESCRIPTION
DIG-IDFONT	IdentafONT Set

Digital MEDIA INCORPORATED



Digital Media Desktop Interactive Learning™

Eliminate pre-press problems, and learn how to avoid them in the first place!

\$99.95



Since the beginning of the desktop revolution, designers, artists, publishers, prepress staff and all production professionals have experienced the delays, frustrations and expense of improper file preparation and film imaging. These award winning Desktop Interactive Learning CD-ROMs address the many problems encountered in every day DTP, as well as more advanced techniques.

All titles have been prepared with the assistance of the software manufacturers as well as power users and service bureaus.

- Features a trouble-shooting section to help fix potential problems
- Cost effective training for your design, production and sales staff
- Trains your clients to send you correctly prepared files improving the client/vendor relationship
- Supplementary course material for existing training programs
- Reduces production time and labor costs
- Reduces overcharges due to imaging problems



Each CD is divided into two sections:

Concepts section – Covers the basics such as the what, why and how of each application and the common problems associated with each one.

Tutorial section – Takes the user on an interactive, step-by-step process of each control, explaining what it means and how it fits into each workflow. *You need these discs, plain and simple!*

MAC PART #	WIN PART #	DESCRIPTION
DIG-0102	DIG-0501	Print Preparation in QuarkXPress
DIG-0201	DIG-0601	Print Preparation in Adobe PageMaker
DIG-0202	—	Adobe InDesign Fundamentals NEW
DIG-0301	DIG-0701	Scanning & Color Correction in Adobe Photoshop
DIG-0003	DIG-0002	File Preparation & Trapping in Adobe Illustrator
DIG-0004	—	Adobe Illustrator 9 Fundamentals
DIG-0815	DIG-0815	Adobe Acrobat 4.0 Fundamentals NEW
DIG-0810	—	Adobe Acrobat & PDF Workflow
DIG-0807	DIG-0808	Compositing Images in Adobe Photoshop & Extensis Mask Pro
DIG-8000	DIG-8001	Preparing Web Graphics in Adobe Photoshop 5.5
DIG-0809	—	Implementing Color Management NEW
DIG-0801	—	Font Management & ATM Deluxe
DIG-0806	—	Preflighting with Extensis Preflight Pro
—	DIG-1000	Outputting Microsoft Publisher 2000 Files NEW

COLORBLIND COLOR MANAGEMENT SOLUTIONS

ColorBlind® Matchbox Plus Publish

The world's first all-in-one color matching system

Put an end to wasted time and proofs. With ColorBlind MatchBox Plus, you get all the tools you need for creating and maintaining ICC profiles for your peripheral color devices in one package. It includes these easy-to-use applications:

- **ColorBlind Matchbox Profiler** – Builds profiles for any scanner, digital camera, display, and all types of output devices from digital color printers to printing presses
- **ColorBlind Edit** – Allows you to fine-tune, apply and attach ICC/ColorSync profiles (complete description below/right)
- **ColorBlind Spot** – A PANTONE® enabled utility for precise spot color calibration
- **Prove it!** – Monitor calibration and profiling system (complete description below/right)

The complete kit also includes:

- IT8 Reflective target for scanner profiling
- Hand-held colorimeter (Color Mouse)
- Prove it! Meter



ColorBlind Prove it! & Prove it! Meter

Quickly and easily calibrate your monitor

➤ **Prove it!** allows you to calibrate and build an ICC profile of your monitor. Prove it! will set your monitor's color temperature (white point) and gamma, and allows you to set the luminance characteristics of any Windows or Mac system using a powerful set of calibration screens. With ColorBlind Prove it! you are getting the best, easy-to-use visual calibration tool available.

➤ **Prove it! with Prove it! Meter** provides the ability to calibrate more accurately by using the Prove it! Meter. The Prove it! Meter offers speed, accuracy and stability. Automating the calibration and profiling procedure with the instrument can establish a visual baseline for precise, soft color proofing.

ColorBlind Edit ICC profile editing

ColorBlind Edit is an ICC profile color editing application. It has several functions, but its main purpose is for editing ICC profiles for correct color. Its other functions include soft proofing (viewing images in correct color on screen), attaching profiles to images, image color editing and applying ICC profiles to scanned images.

DIGITAL

- MatchBox Plus is also available bundled with the Spectrocam spectrophotometer for semi-automatic patch reading and monitor calibration/profiling. See page 17 for details on this device.
- MatchBox Plus is also sold as a software only package for those who are already using other supported measuring devices.



ColorBlind Prove it! & ColorBlind Edit are also available separately

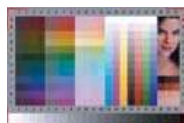

MATCHBOX PROFILER
Calibrate and profile with ColorBlind Matchbox Profiler.



COLORBLIND SPOT
Get accurate PANTONE® or measured spot colors on your output device with ColorBlind Spot.



COLORBLIND EDIT
Fine-tune, apply and attach ICC/ColorSync profiles with ColorBlind Edit.

PART #	DESCRIPTION
DIG-CBMBMA	Matchbox Plus, Mac, Prove it! Meter, ADB and Color Mouse ²
DIG-CBMBMU	Matchbox Plus, Mac, Prove it! Meter, USB and Color Mouse ²
DIG-CBMBWA	Matchbox Plus, Windows, Prove it! Meter, ADB/Serial and Color Mouse ³
DIG-CBMBWU	Matchbox Plus, Windows, Prove it! Meter, USB and Color Mouse ³
DIG-CBMBM	Matchbox Plus, Mac, Software Only ¹
DIG-CBMBW	Matchbox Plus, Windows, Software Only ¹
DIG-CBMBMS	Matchbox Plus, Mac, Spectrocam
DIG-CBPIMA	Prove it! with Meter, Mac ADB ²
DIG-CBPIMU	Prove it! with Meter, Mac USB ²
DIG-CBPIWA	Prove it! with Meter, Windows ADB/Serial
DIG-CBPIWU	Prove it! with Meter, Windows USB
DIG-CBPIM	Prove it!, Mac, Software Only ¹
DIG-CBPIW	Prove it!, Windows, Software Only ¹
DIG-CBEM	Edit, Mac
DIG-CBEW	Edit, Windows

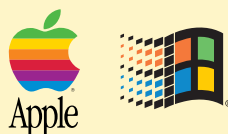

¹ Allows support of selected third-party devices.

² Macintosh G3 and G4 may require an adapter.

³ Some Windows systems may require a minimum video card configuration – contact customer service for further details.

Call about networked versions, and other ColorBlind Color Management Systems.

PANTONE HexImage® Plug-in for Adobe Photoshop

PANTONE HexVector® Plug-in for Adobe Illustrator

Separate images into six-channel Hexachrome within Adobe Photoshop or Adobe Illustrator® to achieve the largest gamut of color for high impact imagery. HexWare is a value-priced package that includes both HexImage and HexVector.



PANTONE ColorWeb® Pro

Advanced color control for Web authoring

Incorporate over 1,000 PANTONE MATCHING SYSTEM Colors plus the 216 "Internet-safe" colors of the PANTONE Internet Color System™ (PICS) into popular Web authoring software applications.

- Point-and-click PANTONE Colors for all Web applications
- Includes two printed fan guides for quick, accurate preview of both "internet-safe" colors and the full PANTONE Solid Color Library

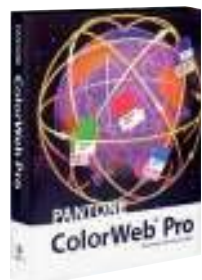

PANTONE OfficeColor Assistant™

Add the impact of PANTONE Colors to all your reports, proposals and presentations in Microsoft Powerpoint®, Word or Excel.

PART #	DESCRIPTION
PAN-HI	PANTONE HexImage for Photoshop
PAN-HV	PANTONE HexVector for Illustrator
PAN-HWARE	PANTONE HexWare
PAN-CWP	PANTONE ColorWeb Pro
PAN-CA	PANTONE OfficeColor Assistant

All PANTONE Software is cross-platformed for Mac and Windows compatibility.



Vivid Details Test Strip® 3.0



The next best thing to Photoshop

Best described as "Photoshop variations on steroids," Test Strip 3.0 is a major new release of the award winning Photoshop® plug-in for color correction. This easy to use color correction tool includes a host of powerful and innovative features designed to make your Photoshop experience more enjoyable, and far more productive. Test Strip is designed for graphic artists, printers, photographers, wide-format printers and service bureaus wishing to achieve accurate color reproduction in the least possible time. Compatible with Mac OS 8, 8.5, 9/Windows 95, 98, NT, 2000/Photoshop 5, 5.5, and 6, ColorSync.

Features include:

- *Metamorphosis* – A guided color correction system
- *Gels* – A hot new correction tool for removing color casts
- *Professional Highlight/Midtone/Shadow Adjustments*
- *Auto Dynamic Range adjustment*
- *Refined grayscale editing*
- *73 photographic filters and 50 special effects filters*
- *Color adjustments in 1% increments*



PART #	DESCRIPTION
DIG-VDTS30	Vivid Details Test Strip Version 3.0



Base-Line Laser Direct™ Plates

The most cost-effective plate for short-run work



This direct-to-plate, dry toner imaging media is ideal for short run applications such as newsletters, business cards, envelopes, flyers or letterheads. Laser Direct Paper Plates offer 5,000 impressions and reproduce screens of up to 95 lpi. Laser Direct Polyester Plates offer 10,000 impressions and reproduces screens up to 120 lpi. They eliminate the need for costly cameras, exposure frames, stripping and plate developing chemistries, greatly reducing the labor time associated with plate production. Packaged 100 plates/box; the polyester are also available in 25-plate packages.

PAPER PLATE PART #	POLYESTER PLATE PART #	SIZE
REL-LP70010	BAS-LDP30005	8 ⁵ / ₈ " x 14"
REL-LP70020	BAS-LDP30010	10" x 15"
REL-LP70040	BAS-LDP30020	11" x 18"
REL-LP70050	BAS-LDP30025	11" x 18 ¹ / ₂ "
REL-LP70060	BAS-LDP30030	12" x 18"

Note: Other sizes are available. The most commonly used sizes are listed, 100 plates.

LITHCOJET INK JET MEDIA

LithcoJET 



All the quality without the price of OEM brand media

Lithco is proud to introduce a line of Ink Jet Media to fit all your needs from comps to proofs, presentations to transfer media.

The highest quality media available value packed with your budget in mind. Your satisfaction is guaranteed. Value packs of 100 sheets/box.



Two-sided Coated Bond Paper

High opacity and dual sided coating makes this paper suitable for two-sided printing. Bright white. Use with either dye or pigmented inks. 100 gsm/26.5 lb.

PART #	U/M	DESCRIPTION
LJT-2SCB81/211	100	Two-sided Coated Bond 8½" x 11"
LJT-2SCB1117	100	Two-sided Coated Bond 11" x 17"
LJT-2SCB1319	100	Two-sided Coated Bond 13" x 19"
LJT-2SCB24150	Roll	Two-sided Coated Bond 24" x 150'
LJT-2SCB36150	Roll	Two-sided Coated Bond 36" x 150'
LJT-2SCB43150	Roll	Two-sided Coated Bond 43" x 150'

Photo Glossy Paper

Designed specifically for all Piezo systems including the Epson 5000. This cast-coated paper is water resistant, dries instantly and handles up to 1440 DPI. Winter white. 170 gsm/45 lb./8 mil.

PART #	U/M	DESCRIPTION
LJT-PG81/211	100	Photo Glossy Paper 8½" x 11"
LJT-PG1117	100	Photo Glossy Paper 11" x 17"
LJT-PG1319	100	Photo Glossy Paper 13" x 19"
LJT-PG24100	Roll	Photo Glossy Paper 24" x 100'
LJT-PG36100	Roll	Photo Glossy Paper 36" x 100'
LJT-PG44100	Roll	Photo Glossy Paper 44" x 100'

Premium Photo Glossy Paper

A microporous ceramic coated photographic super high gloss paper with instant dry and 100% waterproof characteristics. Neutral white. Use with both dye or pigment ink. Thermal or piezo. 180 gsm/8 mil.

PART #	U/M	DESCRIPTION
LJT-PPG81/211	100	Premium Photo Glossy Paper 8½" x 11"
LJT-PPG1117	100	Premium Photo Glossy Paper 11" x 17"
LJT-PPG1319	100	Premium Photo Glossy Paper 13" x 19"
LJT-PPG24100	Roll	Premium Photo Glossy Paper 24" x 100'
LJT-PPG36100	Roll	Premium Photo Glossy Paper 36" x 100'
LJT-PPG44100	Roll	Premium Photo Glossy Paper 44" x 100'

Clear Film and Matte Film

Excellent color fidelity for overhead presentations and overlay comps. Use with both dye or pigment ink. For all thermal or piezo printers. 4 mil.

CLEAR FILM PART #	MATTE FILM PART #	U/M	SIZE
LJT-CF81/211	LIT-MF81/211	100	8½" x 11"
LJT-CF1117	LIT-MF1117	100	11" x 17"
LJT-CF1319	LIT-MF1319	100	13" x 19"
LJT-CF24100	LIT-MF24100	Roll	24" x 100'
LJT-CF36100	LIT-MF36100	Roll	36" x 100'
LJT-CF44100	LIT-MF44100	Roll	44" x 100'

*Interliner available for H-P.

DIGITAL

The Collector™

Save money and protect the environment

Eliminate the need for a technician to replace ink waste reservoirs on your Epson 7000 and 9000 Series printers. This simple system puts the power of the Chemgon™ system to work on spent ink. Divert spent ink into the kit and it is solidified and neutralized making it safe to throw out with your regular industrial waste.



PART #	DESCRIPTION
DIG-TC	The Collector
DIG-TCB	Replacement Bags, Pkg. of 3

Ink Jet Transfer Paper

State of the art cool release technology

Another product from Lithco that allows you to expand your offering to your customers. Simply print on to our special paper and transfer directly onto T-Shirts, hats, bags, or any porous material.

- Use either a heat press or any standard iron
- Cold or hot peel
- Imaged fabric is washable many times without fading

PART #	U/M	DESCRIPTION
LJT-TP81/211	50	Transfer Paper 8½" x 11"
LJT-TP1117	50	Transfer Paper 11" x 17"
LJT-TP1319	50	Transfer Paper 13" x 19"



All LithcoJET media listed are available in additional sheet, roll sizes and thicknesses not listed. A much wider assortment of media is available including:

- Resin Coated (RC) Papers
- Mirror Image Backlit Film
- White Polyester
- Artist Canvas
- Vinyls & Polyesters for signs and banners

PROOFING MEDIA, LASER PLATES & FILM



LithcoJET PROOFING Media

These papers are designed for Piezo printers and are ideal for use on Epson 5000/7000/9000 series printers. They are also compatible with a wide range of other printers including Canon and HP. *Value packs of 100 sheets/box.*



Semi-Matte Proofing Base

Instant drying and water resistant. Bright white. 150 gsm/6.5 mil.

PART #	U/M	DESCRIPTION
LJT-SMPB81/211	100	Semi-Matte Proofing Base 8½" x 11"
LJT-SMPB1117	100	Semi-Matte Proofing Base 11" x 17"
LJT-SMPB1319	100	Semi-Matte Proofing Base 13" x 19"
LJT-SMPB24100	Roll	Semi-Matte Proofing Base 24" x 100'
LJT-SMPB36100	Roll	Semi-Matte Proofing Base 36" x 100'
LJT-SMPB44100	Roll	Semi-Matte Proofing Base 44" x 100'

Matte Proofing Base

A neutral white publication grade matte paper. 170 gsm/8 mil.

PART #	U/M	DESCRIPTION
LJT-MPB81/211	100	Matte Proofing Base 8½" x 11"
LJT-MPB1117	100	Matte Proofing Base 11" x 17"
LJT-MPB1319	100	Matte Proofing Base 13" x 19"
LJT-MPB2465	100	Matte Proofing Base 24" x 65'
LJT-MPB3665	100	Matte Proofing Base 36" x 65'
LJT-MPB4465	100	Matte Proofing Base 44" x 65'



Available soon in 200 gsm for pigment ink.

Photo Glossy Proofing Base

Neutral white color is ideal for all proofing applications. 180 gsm/8.5 mil.

PART #	U/M	DESCRIPTION
LJT-PGPB81/211	100	Glossy Proofing Base 8½" x 11"
LJT-PGPB1117	100	Glossy Proofing Base 11" x 17"
LJT-PGPB1319	100	Glossy Proofing Base 13" x 19"
LJT-PGPB2465	Roll	Glossy Proofing Base 24" x 65'
LJT-PGPB3665	Roll	Glossy Proofing Base 36" x 65'
LJT-PGPB4465	Roll	Glossy Proofing Base 44" x 65'

IRIS Compatible Media

Specially formulated for IRIS printers. Available in Glossy (7 mil.) and Semi-Matte Photo Base anti-curl for series 4000 and 5000 printers (7 mil.) and Matte Presentation Bond (40 lb.).

PART #	U/M	DESCRIPTION
LJT-IRM1218	100	Matte for IRIS 4012 12" x 18"
LJT-IRM1522	100	Matte for IRIS 5030 15" x 22"
LJT-IRM2230	100	Matte for IRIS 5015 22" x 30"
LJT-IRSM1218	100	Semi-Matte for IRIS 4012 12" x 18"
LJT-IRSM1522	100	Semi-Matte for IRIS 5030 15" x 22"
LJT-IRSM2230	100	Semi-Matte for IRIS 5015 22" x 30"
LJT-IRG1218	100	Glossy for IRIS 4012 12" x 18"
LJT-IRG1522	100	Glossy for IRIS 5030 15" x 22"
LJT-IRG2230	100	Glossy for IRIS 5015 22" x 30"

Lithco Laser Film

Heat resistant for use in laser printers or photocopier machines

This film can be imaged in a laser printer or photocopier machine to make negatives or positives for silk screening, pad printing or metal plates. It is recommended to use positive plates because a film positive has much less black area than a film negative. The final image should be enhanced using Toner Aid by Sprayway (see page 66) or an enhancing system.

- .0035" matte coated both sides
- Anti-static coated

PART #	SIZE
FLM-LF81/211	8½" x 11"
FLM-LF81/214	8½" x 14"
FLM-LF1117	11" x 17"
FLM-LF1220	12" x 20"

Packaged 100 sheets per box. Other sizes and enhancing system available, please inquire.

Lithco Laser Plates

CTP for the desktop

Laser Plates represent the economical, quick printing solution for computer-to-plate technology. They allow you to go directly from a digital file and output to plate using a laser printer or photocopier machine. First generation plates have high resolution, sharp images and quick turn-around time.

- No processing chemicals to buy, mix or dispose of
- No camera, stripping or platemaking supplies
- **Double-sided** polyester



- Compatible with oil and rubber based inks
- Daylight handling – no special safelights required
- Use with Burnishine Tone-Away and Laserfont (pages 60, 61)

PART #	SIZE
PLT-LP281/215	8½" x 15"
PLT-LP285/815	8¾" x 15"
PLT-LP21015	10" x 15"
PLT-LP210151/2	10" x 15½"
PLT-LP21118	11" x 18"
PLT-LP211181/2	11" x 18½"
PLT-LP211183/4	11" x 18¾"
PLT-LP212193/8	12" x 19¾"

Packaged 100 plates per box. Other sizes are available, please inquire.



Plate-stretch (plāt' – strèch) – noun, Common occurrence with paper and polyester printing plates, caused by heavy and/or uneven form roller pressures, corrected with PlateStrips. See page 55.

VAN SON INK JET INKS

InkJet Inks

Van Son's EasyPrint and ArtColour inkjet inks have been specially formulated to provide high performance results on today's most popular inkjet printers.

- Maximum fade resistance is provided, ideal for photographic reproduction
- Dry extremely fast
- Improve the visual DPI beyond the limitations of the printer
- Maintain superior color strength and consistency
- Compatible with a wide array of substrates
- Provide optimum fade resistance (ArtColour UV)
- Perform clog-free for more efficient and reliable printing

EasyPrint Inkjet Cartridges for Epson Stylus Printers

COLOR	PART # *	EPSON EQUIVALENT	MODEL #
Black	VL093UV	SO20093	Epson Stylus Color 400, 500, 600, Stylus Photo, Photo 700, Photo EX
Tri-Color	VL089UV	SO20089	Epson Stylus Color 400, 600, 800, 850, 1520
Black	VL187UV	SO20187	Epson Stylus Color 440, 460, 640, 660
Tri-Color	VL191UV	SO20191	Epson Stylus Color 440, 460, 640, 660, 740, 740i, 760, 860, 1160, Stylus Scan 2000, 2500
Black	VL189UV	SO20189	Epson Stylus Color 740, 740i, 760, 860, 1160, Stylus Scan 2000, 2500
Black	VL108UV	SO20108	Epson Stylus Color 800, 850, 1520
5-Color	VL193UV	SO20193	(Photo) for Epson Stylus Photo 750
5-Color	VL110UV	SO20110	(Photo) for Epson Stylus Photo, Photo 700, Photo EX



ArtColour Inkjet Cartridges for Epson Stylus Printers - 3000, 5000 & 9000

COLOR	MODEL 3000 PART # *	MODEL 5000 PART # *	MODEL 9000 PART # *
Yellow	VL3000CA	VL5000CA	VL9000CA
Magenta	VL3001CA	VL5001CA	VL9001CA
Cyan	VL3002CA	VL5002CA	VL9002CA
Black	VL3003CA	VL5003CA	VL9003CA
Lt. Cyan	—	—	VL9004CA
Lt. Magenta	—	—	VL9005CA
Yellow UV	VL3000CAUV-R	VL5000CAUV-R	VL9000CAUV-R
Magenta UV	VL3001CAUV-R	VL5001CAUV-R	VL9001CAUV-R
Cyan UV	VL3002CAUV-R	VL5002CAUV-R	VL9002CAUV-R
Black	VL3003CAUV-R	VL5003CAUV-R	VL9003CAUV-R
Lt. Cyan UV	—	—	VL9004CAUV-R
Lt. Magenta UV	—	—	VL9005CAUV-R

ArtColour Ink Kits for Encad, Novajet Pro™ and Pro E

Kits contain 1 – 500 ml bottle ink, 1 syringe and 1 cartridge.

COLOR	500 ml PART # *	ENCAD, NOVAJET PRO ** PART # *	PRO E PART # *
Yellow	VL100EI	VL100IK	VL100 IKE
Magenta	VL101EI	VL101IK	VL101 IKE
Cyan	VL102EI	VL102IK	VL102 IKE
Black	VL103EI	VL103IK	VL103 IKE
Yellow – UV	VL300EI	VL300IK	VL300 IKE
Magenta – UV	VL301EI	VL301IK	VL301 IKE
Cyan – UV	VL302EI	VL302IK	VL302 IKE
Black	VL303EI	VL303IK	VL303 IKE

*NOTE: Add VAN- before each number above to form a complete Lithco part number.

**36" and 50"



VAN SON DIGITAL DUPLICATOR INKS & MASTERS

Digi-Ink™

Engineered to provide high performance results in today's most popular digital duplicators

- Dries fast due to its dense pigmentation
- Eliminates smudging, offsetting and tracking
- Produces more copies per cartridge
- Unparalleled levels of density and sharpness
- Provides consistent and reliable performance

Digi-Ink™ Black for Riso and Ricoh

PART #*	MODEL #	SIZE	PACKAGING
VL14RS10/2	Riso GR 3770	1000 cc	2 per box
VL13RS10/2	Riso GR, RC, RA Series	1000 cc	2 per box
VL15RS10/2	Riso FR Series	1000 cc	2 per box
VL69RS8/2	Riso CR 1610	800 cc	2 per box
VL13RC6/5	Ricoh	600cc	5 per box
VL13RC10/5	Ricoh	1000cc	5 per box
VL13RC10/5HD	Ricoh High Density	1000cc	5 per box

Sold by the box.

Digi-Ink™ Colors for Riso

- 1000cc Universal Cartridges for All RA/RC/GR Risograph® Digital Duplicators
- Colors are approved and licensed by Pantone, Inc.
- PANTONE Special Mix Colors are available, 6 tube minimum

COLOR	PART #*
Yellow – PANTONE Yellow	VL0000RS
Orange – PANTONE Orange 021	VL0021RS
Red – PANTONE Warm Red	VL0001RS
Bright Red – PANTONE 032	VL0032RS
Burgundy – PANTONE 221	VL0221RS
Marine Red – PANTONE 186	VL0186RS
Blue – PANTONE Process Blue	VL0006RS
Federal Blue – PANTONE 288	VL0288RS
Reflex Blue – PANTONE Reflex Blue	VL0005RS
Medium Blue	VL9000RS
Teal – PANTONE 321	VL0321RS
Green – PANTONE 354	VL0354RS
Hunter Green – PANTONE 342	VL0342RS
Purple – PANTONE 2597	VL2597RS
Grey – PANTONE 422	VL0422RS
Brown – PANTONE 470	VL0470RS
Gold – PANTONE 1245	VL1245RS

Packaged 2 cartridges per box. Sold by the box.

Digi-Ink™ Colors for Ricoh 600CC Cartridge

COLOR	PART #*	COLOR	PART #*
Yellow	VL0000RC	Maroon	VL9001RC
Red	VL0001RC	Orange	VL0021RC
Blue	VL0006RC	Teal	VL0321RC
Green	VL0354RC	Reflex Blue	VL0005RC
Brown	VL0470RC	Navy	VL9000RC
Purple	VLPURPRC		

Packaged 5 units per box. Sold by the box.

NOTE: PANTONE Special Mix Colors are available.

*NOTE: Add VAN- before each number above to form a complete Lithco part number.



Digi-Masters™ for Riso & Ricoh

PART #*	APPROX. SIZE	MODEL #
GRA3600	11" x 17"	GR 3770
GRA3	11" x 17"	GR 3750
FRA3	11" x 17"	FR 3910, 3950
RCA3	11" x 17"	RC 6300
GRA4	8.5" x 14"	GR 2750, GR 2710, GR 1750, GR 1700
FRA4	8.5" x 14"	FR 2950
RA/RCA4	8.5" x 14"	RC 5800, RC 5600, RC 4500, RC 4000, RA 5900, RA 4900, RA 4200
TRA4	8.5" x 11"	TR 1510, CR 1610
SSB4	10" x 14"	Standard SS Series, Ricoh SS810, 830, 915, 935, 950, 955, Gestetner 5000 Series, 5110, 5170, 5210, 5230, 5270, Savin 3200DNP
SSB4	10" x 14"	Standard VT Series, 2105, 2200, 2250, 2300, Gestetner 5325, 5327, 5329L, 5330, 5360, 3250DNP (B4)
VTA4	8.5" x 11"	Standard VT Series, 1730, 1800, 2130, Savin 3000 Series, Savin 3100DNP, Gestetner 5000 Series, 5303, 5304, 5315 (A4)
VTA3	11" x 17"	Gestetner 5375, 5380, 5385, Ricoh VT3500, 3600, 3800, Savin DSD3000, 3300DNP, Standard VT3600, 3800 (A3)
VTA3600	11" x 17"	Gestetner 5390, Ricoh VT6000, Standard VT6000, Savin 3400DNP(A3)

Packaged 2 rolls per box. Sold by the box.



See pages 78-79 for Van Son conventional inks.

Cyber-Fabric™ Magnetic Wiping Cloth

Works great on monitors and scanners

This next generation of "magnetic" wiping fabric removes contaminants from all pre-press surfaces without the need of glass or film cleaning liquids.



- Micro-porous, permanently charged surface holds dirt like a sponge
- Extra-soft for surface-safe cleaning
- Durable, re-usable, long lasting, and even machine washable

PART #	DESCRIPTION
MIS-CF	17"x 18" Cyber-Fabric Wipes

Paraffin Oil

The traditional mounting fluid for film on scanners

Paraffin Oil has been used for mounting film to drum scanners for years. It is especially effective for film requiring "extra hold", such as curled film.



- Safe for use on all films and drums
- High flash point – non-flammable
- Packaged in 500 ml glass bottles

PART #	DESCRIPTION
CHM-PO	Paraffin Oil

Noglare™ Monitor Hoods



Reduce glare on monitors caused by fluorescent lights, windows and photographic studio lighting

Manufactured from durable 60 point solid black chipboard with vinyl-reinforced, adjustable hinges. Color perception on the monitor will no longer be affected by outside light sources.



- Fits a majority of monitors from 14" up to 22"
- Complete, easy installation – no tools required
- Removable Velcro® tabs hold hood firmly in place
- Also functions as a privacy screen
- Great for the color manager who requires monitor stability
- Economical

Kami Scanner and Prepress Supplies

The premier name in scanner products

PART #	SIZE	DESCRIPTION
CHM-KAMISMF	1 Liter Bottle	Scanner Mounting Fluid
CHM-KAMIDC	1 Liter Bottle	Scanner Drum Cleaner
CHM-KAMISX	8½ oz. Aerosol	Scannex Anti-Newton Spray
CHM-KAMIRC	1 Liter Bottle	Film Cleaner
CHM-KAMIST1/2	Roll – ½"	Scanner Mounting Tape
CHM-KAMIST1	Roll – 1"	Scanner Mounting Tape
CHM-KAMISP	N/A	Scan Pack*

Starter kit containing ten different Kami products, MSDSs and product description sheets.



PART #	SIZE	FITS MONITORS
DIG-NG15	15"	14" to 17½"
DIG-NG17	17"	14½" to 18"
DIG-NG21	21"	18½" to 22"



Photex Scanner Wipes are located on page 113.



A



B



C

Dust-Off® Digital Cleaning Kits

Complete maintenance kits for scanners, cameras and office equipment

PART #	DESCRIPTION	CONTENTS
DOF-DMSC	Dust-Off Scanner Cleaning Kit (A)	Contains five Lint-Free Wipes, eight Wet-Dry Scanner Cleaning Wipes, a Plastic Scraper, 4 oz. Spray Bottle of Anti-Static Multi-Purpose Cleaner, a 1.75 oz. Dust-Off Mini and three Laser Printer Cleaning Sheets
DOF-DMDC	Dust-Off Digital Camera Cleaning Kit (B)	A 1.75 oz. Dust-Off Mini, four Dry Swabs and a Micro-fiber Cleaning Cloth
DOF-DMDW	Dust-Off Image Care Kit (C)	A Dust-Off Jr., one Micro-fiber Cleaning Cloth, 4 oz. Spray Bottle of Anti-Static Multi-Purpose Cleaner, ten Wet-Dry Scanner Cleaning Wipes, six Dry Swabs, a Plastic Scraper, ten Lint-Free Wipes and three Laser Printer Cleaning Sheets



Lithco Easy Clean™ Processor Roller Cleaner Sheets

The easiest and most efficient way to clean processor transport rollers

Scrap film or polyester cleaner sheets simply do not clean effectively. Now you can safely clean the transport rollers in your automatic film processor without using hazardous chemicals and without removing the roller pack. Easy Clean sheets are coated with a special adhesive that effectively lifts silver and chemical build-up from rollers. Less wasted film, less opaquing, fewer remakes and less downtime reduce operating costs. Compatible with all photographic film and paper processors with transport rollers and internal dryers. Packaged 50 sheets per box.

PART #	SIZE
FLM-EC216	2 $\frac{3}{8}$ " x 16"*
FLM-EC1417	14" x 17"
FLM-EC1624	16" x 24"
FLM-EC1636	16" x 36"

*Designed for 1-hour film processors.

Stouffer Cameraman's 12-Step Gray Scale

12-Step opaque guide with density increments of 0.15. A 256-line cross pattern provides a quality check on focus and resolution. Combines the effect of 40 or more variables encountered in making excellent negatives for visually determining optimum development.



PART #	DESCRIPTION
MIS-SGSC12	Cameraman's 12-Step Gray Scale

Edwal TT&S™ – Tank, Tray and Systems Cleaner

Removes even your most stubborn stains

This three part cleaning system effectively and quickly removes silver residue from all photo trays, processor tanks and racks. Parts "A" and "B" are used for cleaning; Part "C" is used to neutralize any residual cleaner to prevent contamination of processing chemistry.



PART #	SIZE	DESCRIPTION
CHM-EDWALA	Quart	Edwal Cleaner Part A
CHM-EDWALB	Quart	Edwal Cleaner Part B
CHM-EDWALC	Quart	Edwal Neutralizer Part C

Sherman's Safe Tray & Processor Cleaners

No harsh chemicals – Safe for you – Safe for the environment

Sherman's products **do not contain** sulfuric acid or dichromate mixtures. Use Safe Tray Cleaner to clean both the developer and fixer trays; no need for two different products. The Processor Clean-up is versatile for all types of processors, including lith, rapid access, diffusion transfer and stabilization. Caution: Safe Tray Cleaner is 15% more concentrated than Processor Clean-up and may damage rollers if used in processors.



PART #	SIZE	DESCRIPTION
CHM-SHTC	Quart	Safe Tray Cleaner
CHM-SHPC	Quart	Processor Clean-up

Chemgon

Protect your business from regulatory violation, and the environment from toxic pollutants



Chemgon is a self-contained disposal system for waste photo chemistry such as lith or rapid access developer and fixer, or black plate activator and stabilizer. Simply pour in spent fluids. The patented, proprietary, gel-like encapsulating, chelating and neutralizing polymer forms a sponge-like crystal substance in the Chemgon when it combines with the chemistry. *When this substance solidifies, it may safely and legally be thrown away in your regular industrial trash.*

- Each Chemgon unit will treat five gallons of photo chemistry
- Work either directly from a tray or as the overflow from your processor
- Easy to use, economical
- Complies with EPA regulations 40 CFR §260 to 299



PART #	DESCRIPTION
MIS-CG	Chemgon

NACCO PRODUCTS



Nacco has been a leading producer of photographic, plate and pressroom chemicals since 1918. Their reputation over the years has been to provide quality products at economical prices. Lithco is pleased to offer these fine products for your use.

Developers and Fixers

PART #	DESCRIPTION	SIZE
NAC-177	Nacolith 611 A & B Developer – A two-part, high contrast lithographic developer – Dilutes 1:3	2 x 1 Gallon Set
NAC-347	Naccoset 5 Developer/Replenisher – Excellent results with all rapid access films and papers and all imagesetting materials – Dilutes 1:4	1 Gallon
NAC-213	Icon HD Developer – Designed for the new generation of high definition, hard dot films and papers – Dilutes 1:2	1 Gallon
NAC-343	RA 63 Developer – Ready-to-use, hard working rapid access developer	1 Gallon
NAC-220	RA 68 Fixer – Ready-to-use rapid access fixer	1 Gallon
NAC-262	ZIPFIX – A premium, non-hardening rapid working fixer – Dilutes from 1:4 up to 1:9	1 Gallon

Powder Developers and Fixers

Why pay more for shipping water!

Benefits of buying powder:

- Reduces freight costs
- Long shelf life – two years
- Save on storage space
- Can be mixed with any tap water
- Reduces inventory of chemicals



PART #	DESCRIPTION	MAKES
NAC-420	Lithographic A & B Developer – Clean working, high contrast developer for both line and halftones	2 x 1 Gallon Set
NAC-1041	Rapid Access Developer – High energy developer/replenisher, producing excellent results with RA films and papers and imagesetting materials	1 Gallon
NAC-1043	Rapid Access Developer – Same as NAC-1041	5 Gallons
NAC-1046	Rapid Access Fixer – Designed for use with all RA materials including imagesetting, lithographic and RC papers	1 Gallon
NAC-1045	Rapid Access Fixer – Same as NAC-1046	5 Gallons

Camera Films

Process with Nacco or your favorite chemistry

PART #	DESCRIPTION	SIZE
NAC-5071	N-87 All Purpose Lith Film – Red-light safe, .004" base holds size, dries fast and flat with medium etchability	10" x 12"
NAC-5073	N-87 All Purpose Lith Film – Same as NAC-5071	12" x 18"
NAC-5102	N-80 Rapid Access Film – Red-light safe. .004" base, high contrast, high density, medium to fast speed with rapid development	10" x 12"
NAC-5104	N-80 Rapid Access Film – Same as NAC-5102	12" x 18"

Packaged 100 sheets per box.



Graduated Cylinders

Perfect for photochemistry applications and mixing fountain solutions

Clear, high-impact plastic for accurate measurement. Compatible with most solvents.

- Rinses clean easily
- Graduated in ounces and milliliters

PART #	DESCRIPTION
MIS-GC16	16 oz. Capacity
MIS-GC32	32 oz. Capacity



Plastic Print Tongs

Made from high-impact plastic, these flexible tongs protect your hands and fingers from your film processing chemistry. The ends are specially shaped to prevent damage to film and papers. Tongs measure 8" long and are sold 2/package.

PART #	DESCRIPTION
MIS-PTP	Plastic Print Tongs



See page 64 for Nacco Silverchem and metal plate chemistry.



IMPORTANT INFORMATION FOR CHOOSING THE RIGHT SAFELIGHT

A safelight is defined as the roomlight illumination that will not fog photographic materials during the time period required for normal handling and processing. This can range from approximately three minutes for scanner films and up to fifteen minutes for slow orthochromatic emulsions.

Distance also plays an important part in safelight determination.

Manufacturer tests are determined with light sources five feet from the working area. If you experience a fogging problem, move the lights further away from the work area.

The recommended quantity of safelights for a given area is one four foot light per 50 square feet of work area.



Cesco Developing Trays

Cesco Darkroom Developing Trays are made of high-density polyethylene and have high-impact strength. The trays feature flat bottoms to assure even, consistent developing.

- Chemical and stain resistant
- Rugged construction provides years of use

PART #	FITS FILM SIZE
MIS-DT810	8" x 10"
MIS-DT1012	10" x 12"
MIS-DT1114	11" x 14"
MIS-DT1417	14" x 17"
MIS-DT1620	16" x 20"
MIS-DT2024	20" x 24"
MIS-DT2328	23" x 28"
MIS-DT3040	30" x 40"



EncapSulite®



Convert your fluorescent lights into safelights for any process

EncapSulite is the quick, easy and economical way to convert existing fluorescent lighting fixtures into safelights for every photographic, platemaking and proofing process. Sleeves are available in both T12 and the smaller T8 diameters. Fluorescent safelights provide the following benefits:

- Energy saving – low power consumption
- Fade-free filters
- Brighter, fog-free lighting for a better working environment
- Shadowless illumination results in less eyestrain
- Sleeves are designed to contain glass in the event of breakage



HANDY TIP

Use the UVC Sleeve for UV sensitive materials and the V50 Sleeve for Agfa Lithostar plates.

SAFELIGHT SLEEVES

PART # *	SIZES	SAFELIGHT	DESCRIPTION	SPECTRAL LIMIT **
ENC-SOR10*	24", 48", 96"	R10	Standard Ortho Red	610 nm
ENC-SOR20*	24", 48", 96"	R20	Deep Ortho Red	625 nm
ENC-SOA5ND3*	24", 48", 96"	A5ND.3	Amber Yellow	555 nm
ENC-SOYG10*	24", 48", 96"	YG10	Yellow - Gold	500 nm
ENC-SOG10*	24", 48", 96"	G10	Platemaker Yellow	475 nm
ENC-SOV50*	24", 48", 96"	V50	Lithostar Yellow	420 nm
ENC-SOC20*	24", 48", 96"	C20	UV Daylight White	400 nm
ENC-SOUVC*	24", 48", 96"	UVC	UV Blocking Clear	380 nm
ENC-SOS15ND225*	24", 48", 96"	S15ND2.25	Dark Green	535 to 560 nm
ENC-SOT20ND75*	24", 48", 96"	T20ND.75	Blue - Green	470 to 530 nm
ENC-SOT20ND105*	24", 48", 96"	T20ND1.05	Blue - Green	471 to 528 nm
ENC-SOT30ND105*	24", 48", 96"	T30ND1.05	Blue - Green	483 to 518 nm
ENC-SOT40*	24", 48", 96"	T40	Green for Infrared	470 to 528 nm

* Follow this part number with the length required to obtain the correct shield and indicate T12 or T8.

** Nanometers

Note: The most common safelights are listed above. Also available are all other styles of sleeves, as well as complete safelights (fluorescent tube, shield, filter, end caps), single and double lamp systems (includes complete safelight plus electrical fixture), laminated safelight filter panels, Mighty Lites and Window Filters. Contact your Lithco Dealer, Lithco Customer Service or click on web link #P451 for information on these products and for help selecting the proper safelight for your film.

PROCAM DARKROOM ACCESSORIES

ProAir Processor Air Cleaner

Eliminate processor odors at the source

Simply connect the ProAir to the 4" exhaust vent on your processor and the ProAir will draw objectionable odors and chemicals out of your processor **directly** into the air cleaner. The air cleaner utilizes a special filter formulated to remove the chemical vapors emitted from processors.

- Traps odors and vapors before they are emitted into the room
- Protects linked Imagesetter electronics from processor fumes
- Durable, non-staining corrosion-proof cabinet, blower, and impeller
- Ideal for imagesetting processors in office environments

PART #	DESCRIPTION
PRO-PA1	ProAir Processor Air Cleaner
PRO-PF1	Replacement Particulate Filter for ProAir
PRO-OVF3	Odor/Vapor Filter for ProAir



Procam Wash-Aid Additive

Increases the time interval between wash water changes in recirculating wash

The Wash-Aid additive is a super-concentrated liquid additive that removes residual fixer-induced silver complexes.

- Fights algae, bioslime and other similar, undesirable tank deposits
- Outperforms other wash water additives
- Runs cleanly for extended periods of time
- 2.5 gallon container yields 106 gallons of working strength solution

PART #	DESCRIPTION
PRO-WA25	Wash-Aid Additive



P
R
E
P
R
E
S
S



Chemical Storage Tanks

Tanks nest for storage, reduced shipping costs

Set of two tanks. Ideal for replenishers or mixing bulk chemistry. Also available with fittings and valve.

PART #	DESCRIPTION
PRO-CTS75	Chemical Storage Tanks – Set of Two 7.5 gal. each
PRO-CTV75	Chemical Storage Tanks w/Fittings and Valve – Set of Two 7.5 gal. each

Algae Clear® II Feeder Housing

Eliminates algae growth in processor wash tanks

Designed to be installed in the water supply line between the water control panel and the processor. It is provided with 1/2" I.D. plastic hose barbs to facilitate easy installation.

- Automatically meters between one to three ppm EPA registered, bromine-based biocide into the wash water
- Reduces costly downtime needed to clean processing equipment
- Reduces wasted film and remake labor
- Safe and effective in all photo processing applications
- Helps reduce BOD in waste wash water
- Housing shipped with 5 lb. of Algae Clear tablets
- Optional one micron pre-filter with mounting panel available



Do not use Algae Clear tablets directly in processor wash tank.

PART #	DESCRIPTION
PRO-AC1000	Algae Clear II Feeder Housing w/5 lb. Tablets
PRO-AC2000	Algae Clear II Feeder Housing, Pre-Filter and Mounting Panel w/5 lb. Tablets
PRO-ACT5	Algae Clear Tablets – 5 lb. Pail

GLOVES & DUST CONTROL



POLYGENEX™

Polygenex International is a leading manufacturer of gloves for photographic, prepress, electronic and clean-room assembly areas. Their unique products will change the way you feel about gloves.

Polygenex™ All-Day® Nylon Lab Gloves



Polygenex All-Day Micro-Dot™ Gloves



Ultra-thin design provides better tactile properties

Specifically designed as a lint-free glove for handling film, proofs, transparencies, photo prints and digital output, Polygenex gloves eliminate fingerprints and scratches. These gloves are dust free and combine thinness and close fit while minimizing clamminess and sweating. Ergonomic, stretch-knit design helps reduce hand strain and user discomfort. Unique fingertip design on **Micro-Dot** gloves provides maximum dexterity.

- Meet the demands of all photographic and prepress professionals
- Seam-free construction from a new PHA fiber for long-term use
- Elastic cuff keeps gloves in place
- Ambidextrous, reusable and launderable
- Provide excellent dexterity and sensitivity during routine procedures
- Protect film, plates, inkjet prints, photographs and circuit boards from fingerprints
- Available with micro-dots on one-side, or two-sided for increased glove life
- Packaged five pair of the same size per box

PART #	SIZE	DESCRIPTION
GLV-NLGU	Universal	All-Day Nylon Lab Gloves
GLV-NLGXL	X-Large	All-Day Nylon Lab Gloves
GLV-NLGM1U	Universal	All-Day Micro-Dot Gloves – Dots One-side
GLV-NLGM1XL	X-Large	All-Day Micro-Dot Gloves – Dots One-side
GLV-NLGM2U	Universal	All-Day Micro-Dot Gloves – Dots Two-sides
GLV-NLGM2XL	X-Large	All-Day Micro-Dot Gloves – Dots Two-sides

*Universal fits most hands. If your hand is very large, order the X-Large.



ALL-DAY NYLON LAB GLOVE



ALL-DAY MICRO-DOT GLOVE



Particulate Cleaner Roller & Tacky Pad System

Don't just blow dust around... trap it with the PCR and Tacky Pad System

Safely removes dust, lint and dirt from vacuum frames, contact boards, film, plates, proofs, ink jet prints, and camera backs.

- Use in sign making to clean surfaces before applying vinyl lettering or silk screening
- Use before laminating to insure the perfect bond
- Proprietary elastomer roller will not scratch any substrate
- Roller has a ball burnished aluminum frame with sure grip rubber handle
- Remove contaminants from the roller with disposable sheets of the Tacky Pad
- Each roller is sold with one complementary 50-sheet pad – additional Tacky Pads are sold separately

PART #	DESCRIPTION
MIS-PCR4	4" Particulate Cleaner Roller
MIS-PCR6	6" Particulate Cleaner Roller
MIS-PCR12	12" Particulate Cleaner Roller
MIS-PCR18	18" Particulate Cleaner Roller
MIS-PCR24	24" Particulate Cleaner Roller
MIS-PCRPAD	Tacky Pad – 8" x 13" 50 Sheets



Lithco White Cotton Gloves

Eliminate fingerprints

White cotton inspector's gloves are made from smooth, lightweight, durable and washable 100% cotton. Protect sensitive materials including film, plates, ink jet prints, photographs, circuit boards and more. Interchangeable, one size fits all.

PART #	DESCRIPTION	QUANTITY
GLV-C	Lithco White Cotton Gloves	2 Pairs
GLV-CB	Lithco White Cotton Gloves, Bulk Packaged	48 Pairs

P
R
E
P
R
E
S
S

STATIC & DUST CONTROL

Kinetronics® Anti-Static Gloves



A remarkable blend of soft conductive and synthetic fibers

These conductive gloves suppress dust collecting electrostatic charges when handling delicate or sensitive static-prone materials. Sold in pairs and made in three sizes to comfortably fit small, medium and large size hands.

- Resistivity of seven megohms provides excellent conductivity
- Special construction and design eliminates arcing, prevents unintended shocks
- Prevent fingerprints and scratching on film, optics, glass and electronic components
- Reusable – wash with mild soap or detergent when soiled; tumble dry on warm setting

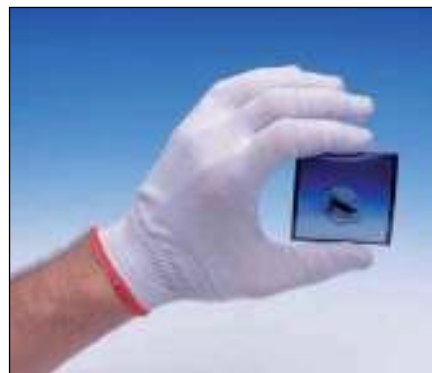

Kinetronics Anti-Static Cloth



A special blend of soft, non-toxic synthetic fiber and non-abrasive conductive filament

With a simple wipe, the lint-free, ultra-soft, microdenier knit effectively dissipates surface static charge and gently removes fingerprints, smudges, dust, dirt and other debris from sensitive materials. This is a technically superior, dry anti-static cloth that can be used to safely clean film, photographic equipment, CDs and DVDs and electronic components.



- Outperforms "treated" anti-static cloths
- The four megohm resistivity provides excellent conductivity
- Not wet or soggy – cannot dry out and lose effectiveness
- May be used over-and-over again
- Wash with a gentle soap or detergent; tumble dry on warm setting
- Generous 10" x 18" size

PART #	SIZE	DESCRIPTION
GLV-KTASGS	Small	Kinetronics Anti-Static Gloves
GLV-KTASGM	Medium	Kinetronics Anti-Static Gloves
GLV-KTASGL	Large	Kinetronics Anti-Static Gloves
MIS-KTASC	10" x 18"	Kinetronics Anti-Static Cloth

Kinetronics StaticWisk™ Anti-Static Brushes



Ideally suited for a variety of applications

These brushes are used to remove static and dust in photographic, digital image scanning, graphic arts, industrial and scientific applications.

- Safe to use on film, lenses, plastics and papers
- Very soft blend of natural goat hair and special conductive fiber
- Effective static dissipation without electronics or radioactive materials
- Saves time and money by increasing production and improving quality
- Furnished with a vinyl storage pouch



PART #	MODEL	WIDTH	DESCRIPTION
MIS-KNSW140	SW-140	5½"	Kinetronics StaticWisk Brush
MIS-KNSW280	SW-280	11"	Kinetronics StaticWisk Brush

STATICMASTER® Brushes

STATICMASTER neutralizes static and with its soft, hand-crafted brush, whisks away dust and dirt in one quick, easy operation. STATICMASTER's Polonium 210 element generates ionized air which neutralizes both positive and negative electrostatic charges that hold and re-attract foreign particles such as dust or lint. A connector is available for joining two or more 3" cartridges to make a wider brush.

- Ideal for negatives, proofs, transparencies, slide mounts, film holders, enlargers, printers, filters and lenses
- A critical tool in any darkroom



PART #	DESCRIPTION
MIS-SM1C200	1" STATICMASTER Brush
MIS-SM1C200R	1" Replacement Cartridge
MIS-SM3C500	3" STATICMASTER Brush
MIS-SM3C500R	3" Replacement Cartridge
MIS-SMCON	Connector



Inquire about anti-static bars for your graphic arts equipment, including laminators, film processors and sheeters.



Dust Controller

Roll-away dust and particulate contaminants

This easy to use roller removes contaminants from any surface.

- Especially useful on vacuum frame bladders, including under and on the top of the bin board
- Economical to use on all vacuum frames
- Long lasting, top quality contaminant-remover tape is cut into individual sheets for fast removal and no waste
- Use to remove contaminants from the Poliwand fabric

PART #	DESCRIPTION
MIS-DC	Dust Controller (1 handle + 1 4" x 30' roll of tape)
MIS-DCCS	Dust Controller Case (1 handle + 12 4" x 30' rolls of tape)

Bancheez™ Cloth

Durable, extra low-lint wipers

Bancheez Cloth wipes clean without contaminating your prepress equipment. They do not shed like conventional cheesecloth.



- Highly absorbent, solvent resistant
- Reusable or disposable
- Use on vacuum frames, scanner drums, light tables and copy boards
- Packaged 50 wipes per pack, 12 packs per case

PART #	DESCRIPTION
MIS-BANCHEEZ	Bancheez Cloth

Impress™ Antistatic Protective Coating

Not a glass cleaner, IMPRESS protects glass with an antistatic coating

This unique solution prevents dirt, dust and lint particles from adhering to surfaces.

- Eliminates friction to reduce static build-up
- Reduces draw-down cycle time in vacuum frame
- Reduces and helps to eliminate film registration distortion
- Available as a liquid or in handy, convenient pre-moistened towels (20 – 10" x 12" towels per canister)



PART #	DESCRIPTION
NAR-IMP2	2 oz. Impress with Fingertip Mister
NAR-IMP4	4 oz. Impress with Fingertip Mister
NAR-IMP16	16 oz. Impress
NAR-IMPTS	Trigger Sprayer
MIS-IMP	Impress Pre-moistened Towels
MIS-DBKIT	Dust Bunny System Start-up Kit

IMPRESS AND DUST BUNNY SYSTEM START-UP KIT

Contains six 4 oz. Impress, 12 Bancheez Cloths, six Dust Bunny Cloths, one 16 oz. Improve Plus Glass Cleaner.

Dust Bunny Magnetic Wiping Fabric

Attracts dirt and dust like magic... easily washes clean

Permanently charged polymer wiping fabric attracts dirt, dust, lint and other nuisance particles. Surfaces treated with IMPRESS allow the "magnetic" wiping fabric to remove all types of dirt, never releasing it from the "magnetic" fabric until washed in water.

- Durable, re-usable and long lasting
- Machine washable

PART #	DESCRIPTION
MIS-DBW	17" x 17" Dust Bunny Wipes



Poliwand™ Antistatic Film Flattening Wand

Cleans film and eliminates static as it flattens

This special wand eliminates air pockets and decreases draw-down time. Available in a variety of lengths and comes complete with a 2 oz. bottle of IMPRESS used to treat the Poliwand fabric surface, and a Dust Controller used to remove contaminants from the Poliwand fabric.

- Reduces static electricity build-up
- Picks up dust and dirt for cleaner contacts and plates
- Weighted – no pressure required
- Lint-free and long-lasting



PART #	DESCRIPTION
MIS-PW12	12" Poliwand
MIS-PW14	14" Poliwand
MIS-PW16	16" Poliwand
MIS-PW24	24" Poliwand
MIS-PW30	30" Poliwand
MIS-PW40	40" Poliwand



Trupunch Duplicator Registration System

TRUPUNCH is the complete duplicator press registration system

Everything you need for perfect registration. Tighter register control will allow you to bid on those profitable color jobs.

- ▶ Critical for 2- and 4-color work
- ▶ Available in two models for compatibility with all duplicators
- ▶ Reduces re-makes and waste
- ▶ Improves color quality

The complete kits include a 22" x 20" punch, plus:

- ▶ Pinbar for precise light table alignment
- ▶ Plate making insert with retracting pins to ensure perfect contact in the vacuum frame
- ▶ 1/4" Round Adhesive-backed Hole Strengtheners (1 box of 250)
- ▶ 3/16" Slotted Adhesive-backed Hole Strengtheners (1 box of 250)
- ▶ 1/4" Round Adhesive-backed Register Tabs (1 box of 250)
- ▶ 3/16" Slotted Adhesive-backed Register Tabs (1 box of 250)
- ▶ 1/4" Round Register Pins (1 package of 25)
- ▶ 3/16" Slotted Register Pins (1 package of 25)



Register Pins



Designed for maximum accuracy in vacuum frames

Lithco brass register pins offer an economical solution to a wide variety of registration problems. Use the .040" to .110" heights in vacuum frames with a platemaking insert or step-and-repeat template. The .145" and .200" heights work best in stripping applications. The bottom flange allows the pins to be fastened to most surfaces with Lithco Hole Strengtheners. Also available in polycarbonate for situations requiring transparent pins, such as circuit board manufacturing.

PART #	PIN HT.	DESCRIPTION
LIT-RPB8040	.040"	1/8" Round
LIT-RPB8070	.070"	1/8" Round
LIT-RPB1040	.040"	1/4" Round
LIT-RPB1070	.070"	1/4" Round
LIT-RPB1110	.110"	1/4" Round
LIT-RPB1145	.145"	1/4" Round
LIT-RPB1200	.200"	1/4" Round
LIT-RPB4070	.070"	1/4" x 3/16" Slotted
LIT-RPB4110	.110"	1/4" x 3/16" Slotted
LIT-RPB4145	.145"	1/4" x 3/16" Slotted
LIT-RPB4200	.200"	1/4" x 3/16" Slotted

The most popular sizes of brass pins are listed above. Please inquire for other sizes or polycarbonate pins.

	PART #	DESCRIPTION	TYPICAL APPLICATION	EXAMPLES
 LIT-TP1: FOR SMALL PRESSES WITH PINBAR CLAMPS	LIT-TP1	Trupunch Register System	Small presses with pinbar clamps	AB Dick, Multi, Chief, Davidson*, Hamada*, Itek, Ryobi, Toko
 LIT-TP2: FOR SMALL PRESSES WITH PLATE-LOCATING PINS	LIT-TP2	Trupunch Register System	Two-color presses with two 10 mm plate-locating pins on 220 mm centers	Heidelberg GTO, Itek 3985, Ryobi 3302 and 3202 two-color presses
	LIT-TP1A	Hook-bar adapter pins for TP1 system		

*Presses with "hook-bar" clamp require LIT-TP1A adapter pins.



Lithco also carries a complete line of In-line Registration Punches, Register Systems for Imageset and Plateset materials, Contact Boards to integrate mismatched punch systems, and Step & Repeat Systems. Please inquire.

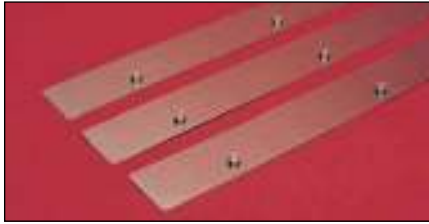

Pinbars

Meticulous construction guarantees position accuracy

Custom made to match your register system; stainless steel pins are mounted to a stainless strip ensuring accurate pin position on the light table or in the vacuum frame. Most common pin sizes are available in any configuration, in pin heights of .070", .110", .145", and .200". Send punch sample for a quotation.

Lithco Register Marks

PART #	DESCRIPTION
LIT-RMT	Transparent
LIT-RMO	Opaque



Lithco Hole Strengtheners

Made from .005" translucent polyester for flexibility and ease in handling. Use to reinforce holes punched in masking materials, to mount register pins to smooth surfaces or to relocate oversized holes to existing pins.

PART#	HOLE SIZE	STYLE
LIT-HS1	1/4"	Round
LIT-HS2	3/16" x 3/8"	Slotted
LIT-HS3	1/4" x 3/8"	Slotted
LIT-HS4	None	Unpunched
LIT-HS5	1/8"	Round
LIT-HS6	3/16"	Round

Packaged 250/dispenser box.

Lithco Register Tabs

Made from .010" translucent polyester for accuracy and greater stability. Allows you to custom design a registration system when no punch is available. Ideal for use in vacuum frame with Lithco Contact Board (see page 55). Supplied either self-adhesive or non-adhesive. Packaged in poly bags of 250 pieces.

ADHESIVE PART #	NON-ADHESIVE PART #	HOLE SIZE	STYLE
LIT-RT1	LIT-RT1N	1/4"	Round
LIT-RT2	LIT-RT2N	3/16" x 3/8"	Horizontal
LIT-RT3	LIT-RT3N	3/16" x 3/8"	Vertical
LIT-RT4	LIT-RT4N	1/4" x 3/8"	Horizontal
LIT-RT5	LIT-RT5N	1/4" x 3/8"	Vertical
LIT-RT6	LIT-RT6N	None	Blank



Lithco Register Pins with Bases

Made from rust-resistant stainless steel.

Stable base measures 7/8" x 1 3/4".

Packed 10 pins of same height and style per handy plastic storage case.



PART #	PIN SIZE	STYLE	PIN HT.	PART #	PIN SIZE	STYLE	PIN HT.
LIT-RP1070	1/4"	Round	.070"	LIT-RP3145	3/16" x 1/4"	Vertical	.145"
LIT-RP1110	1/4"	Round	.110"	LIT-RP3200	3/16" x 1/4"	Vertical	.200"
LIT-RP1145	1/4"	Round	.145"	LIT-RP4070	1/4" x 5/16"	Horizontal	.070"
LIT-RP1200	1/4"	Round	.200"	LIT-RP4110	1/4" x 5/16"	Horizontal	.110"
LIT-RP2070	3/16" x 1/4"	Horizontal	.070"	LIT-RP4145	1/4" x 5/16"	Horizontal	.145"
LIT-RP2110	3/16" x 1/4"	Horizontal	.110"	LIT-RP4200	1/4" x 5/16"	Horizontal	.200"
LIT-RP2145	3/16" x 1/4"	Horizontal	.145"	LIT-RP5070	1/4" x 5/16"	Vertical	.070"
LIT-RP2200	3/16" x 1/4"	Horizontal	.200"	LIT-RP5110	1/4" x 5/16"	Vertical	.110"
LIT-RP3070	3/16" x 1/4"	Vertical	.070"	LIT-RP5145	1/4" x 5/16"	Vertical	.145"
LIT-RP3110	3/16" x 1/4"	Vertical	.110"	LIT-RP5200	1/4" x 5/16"	Vertical	.200"

PENS & OPAQUES



Correct-A-Neg™ Opaque Pens



PART #	DESCRIPTION
CAP-OPBNP	Needle Point Black
CAP-OPBF	Fine Black
CAP-OPBM	Bullet Black
CAP-OPBW	Wedge Black
CAP-OPRNP	Needle Point Red
CAP-OPRF	Fine Red
CAP-OPRM	Bullet Red
CAP-OPRW	Wedge Red
CAP-OPRTP	Twin Point Red

These opaque pens feature a special formulation of UV absorbers that thoroughly block all light waves to prevent exposure. Even-flowing nibs lay down a rapid drying, thin film that does not creep, spread, crack or chip.

- Waterproof, smudge-proof and light-proof
- Four point styles for ease in matching the pen to the job – Needle point, Fine point, Bullet point and Wedge point
- Available in twin point with Fine and Bullet nibs



China Markers



Handy for writing on film or plastics

China Markers feature a paper-wrapped design and pigments that are moisture-resistant and safe.

- Write on porous or non-porous surfaces
- High quality, smooth writing
- Lightweight
- Available in black or white

PART #	COLOR	DESCRIPTION
CAP-CMB	Black	China Marker
CAP-CMW	White	China Marker

Packaged 1 dozen per box.



Kimoto Pake Super Density Opaque Pens

Kimoto Pake is fast drying and waterproof. High density assures complete light blockage. The "Medium" style is refillable.



BLACK PART #	RED PART #	DESCRIPTION	POINT SIZE
CAP-KIMBSF	CAP-KIMRSF	Super Fine	0.1 mm
CAP-KIMBF	CAP-KIMRF	Fine	1 mm
CAP-KIMBM	CAP-KIMRM	Medium – Refillable	3 mm
CAP-KIMRB	CAP-KIMRR	Refill Solution	N/A

Zig Opaque Pens

Zig opaque covers completely, no retouching or retracing. Opaque flows smoothly without spreading or blurring. Will not crack or peel, and dries almost instantly. An uncapped pen will often recover when put to use again. Color: Red.



PART #	DESCRIPTION
CAP-ZIGOPUF	0.1 mm Ultrafine Tip
CAP-ZIGOPF	0.5 mm Fine Tip
CAP-ZIGOPM	1.0 mm Medium Tip
CAP-ZIGOPB	3.0 mm Broad Tip
CAP-ZIGOPBR	Rubber Brush Tip
CAP-ZIGOPBRR	Big Rubber Brush Tip



Lithco Opaques

Our finest black, red and Black Satin opaques for lithographers

Lithco water-based Lithopaque™ covers almost any smooth surface with one stroke of the brush. Remove with water. Black Satin™ is designed for opaquing where water resistance is desired. Dries rapidly.

PART #	DESCRIPTION
OPQ-LPB2	Lithopaque, Black, 2 oz.
OPQ-LPR2	Lithopaque, Red, 2 oz.
OPQ-LPB8	Lithopaque, Black, 8 oz.
OPQ-LPR8	Lithopaque, Red, 8 oz.
OPQ-BS8	Black Satin 8 oz.
OPQ-BSQ	Black Satin Quart

**BASE
LINE**
Graphic Arts
Products



Non-Reproducing Blue Pens & Pencils

These pens and pencils are perfect for making notations on camera ready art.

- *Transparent blue is not reproduced by cameras and copiers*
- *Pencil lines may be erased*
- *Pencils sold in economical packs of 12*
- *Pens sold individually*

PART #	DESCRIPTION
CAP-NRBF	Fine Pen
CAP-NRBP	Pencils



Opaque Brushes

Each brush is hand-crafted in a traditional, full-bodied head shape, using only the finest bristles. The balanced, hardwood handles fit comfortably in your hand. Chrome-plated ferrules are attached to the handles by both gluing and crimping. Available in a size range from #000 to #5 and in either red sable or synthetic fiber blend.

SIZE	RED SABLE PART #	SYNTHETIC FIBER BLEND PART #
Size 000	OPQ-K000	OPQ-S000
Size 00	OPQ-K00	OPQ-S00
Size 0	OPQ-K0	OPQ-S0
Size 1	OPQ-K1	OPQ-S1
Size 2	OPQ-K2	OPQ-S2
Size 3	OPQ-K3	OPQ-S3
Size 4	OPQ-K4	OPQ-S4
Size 5	OPQ-K5	OPQ-S5

Base-Line Opaque-By-Numbers

Opaque pen kits feature pens with four tip sizes (0.1 mm, 0.3 mm, 0.5 mm, and 3.0 mm) and an opaque solvent pen. Kit is packed in a vinyl storage pouch. Available in red or black. Pens also sold individually.

BLACK PART #	RED PART #	DESCRIPTION
REL-4000B	REL-4000R	Opaque-By-Numbers Kit
REL-4001B	REL-4001R	Opaque Pen 0.1 mm
REL-4003B	REL-4003R	Opaque Pen 0.3 mm
REL-4005B	REL-4005R	Opaque Pen 0.5 mm
REL-4030B	REL-4030R	Opaque Pen 3.0 mm
REL-4010	REL-4010	Solvent Pen
REL-3999B	REL-3999R	Opaque Pen Micro-fine 0.05 mm
REL-4011B	REL-4011R	Fine Point Brush
—	REL-4011L	Fine Point Brush
—	REL-4011R	Red Lacquer
—	REL-4013R	Opaque Pen – Twin Point



Mark-Tex Opaque Pens

ITW mark-tex

Specially formulated water-resistant ink blocks light transmission

Mark-Tex has developed a line of film opaquing pens that prove indispensable in film production and graphic arts. Created for use on film negatives and positives, these pens deal with problems of scratches, pin-holes, cut marks and surface imperfections.

- *Employs patented valve-activated ink-feed*
- *Ink dries in less than a minute*
- *Lightweight plastic bodies*
- *Fine or broad tip; black or red ink*
- *Opaque solvent pen available*



PART #	COLOR	DESCRIPTION
MAR-1100	Black	Mark-Tex #1100 Film Opaque Pen, Fine Point
MAR-1102*	Black	Mark-Tex #1102 Film Opaque Pen, Broad Point
MAR-1200	Red	Mark-Tex #1200 Film Opaque Pen, Fine Point
MAR-1202*	Red	Mark-Tex #1202 Film Opaque Pen, Broad Point
MAR-1000	N/A	Mark-Tex #1000 Opaque Solvent Pen

*#1102 and #1202 will replace the #1101 and #1201 shown.

Sharpie® Permanent Markers

Mark almost anything. Tough resilient tip produces a quick flowing ink that dries fast, resists water and stays permanently.

PART #	TIP	COLOR	NUMBER
CAP-SHBF	Fine	Black	#30001
CAP-SHRF	Fine	Red	#30002
CAP-SHBLUF	Fine	Blue	#30003
CAP-SHGRF	Fine	Green	#30004
CAP-SHBEF	Extra Fine	Black	#35001
CAP-SHBLUEF	Extra Fine	Blue	#35003
CAP-SHBUF	Ultra Fine	Black	#37001
CAP-SHBLUUF	Ultra Fine	Blue	#37003



P
R
E
P
R
E
S
S

PROOFING PAPER & MASKING FILM

LithoProof™ Blue Proofing Paper



Bluelines for less!

LithoProof is a totally dry and odorless, instant imaging proofing paper that requires no chemicals to process. It provides a dense blue image with superior dot fidelity, allowing you to show excellent color breaks. The background of LithoProof clears to a whiter "white", providing your customers with clear and attractive proofs.



LithoProof is exposed with a UV filter. The background is cleared with room light or by using a UV absorbing filter in the exposure unit. The light source and type of filter determines the exposure time and overall quality of the final proof.

- ▶ An ideal drop-in for your current product with minimal or no changes in exposure, clearing times or equipment
- ▶ Use with both negative and positive film
- ▶ Economical
- ▶ Single sided or double sided



LITHOPROOF IN EXPOSURE FRAME



LITHOPROOF AFTER INITIAL EXPOSURE



LITHOPROOF AFTER CLEARING

1-SIDED PART #	2-SIDED PART #	SIZE
FLM-LP1B1 218	FLM-LP2B1 218	12" x 18"
FLM-LP1B1 620	FLM-LP2B1 620	16" x 20"
FLM-LP1B2024	FLM-LP2B2024	20" x 24"
FLM-LP1B2228	FLM-LP2B2228	22" x 28"
FLM-LP1B2436	FLM-LP2B2436	24" x 36"
FLM-LP1B2538	FLM-LP2B2538	25" x 38"
FLM-LP1B3040	FLM-LP2B3040	30" x 40"
FLM-LP1B24300	FLM-LP2B24300	24" x 300'
FLM-LP1B30300	FLM-LP2B30300	30" x 300'
FLM-LP1B36300	FLM-LP2B36300	36" x 300'
FLM-LP1B42300	FLM-LP2B42300	42" x 300'

All sheets sizes are packed in convenient 200 count boxes. Other sizes available.



Ulano Rubylith® and Amberlith®

PART #	SIZE	Q/T*	GAUGE	TYPE
ULA-3DA40150	40" x 150"	Q	.003"	Amberlith
ULA-3DA40300	40" x 300"	Q	.003"	Amberlith
ULA-A3A40150	40" x 150"	T	.003"	Amberlith
ULA-A3A40300	40" x 300"	T	.003"	Amberlith
ULA-D3R40150	40" x 150"	Q	.003"	Rubylith
ULA-D3R40300	40" x 300"	Q	.003"	Rubylith
ULA-RM340150	40" x 150"	T	.003"	Rubylith
ULA-RM340300	40" x 300"	T	.003"	Rubylith
ULA-5DR40300	40" x 300"	Q	.005"	Rubylith
ULA-5DM40300	40" x 300"	T	.005"	Rubylith

* Q = Quick Strip, T = Tacky

Plate Developing Pads



The most efficient method of hand developing plates

Using developing pads makes hand developing more efficient by minimizing the amount of chemistry required while maximizing the removal of the subtractive coating. They also keep potentially harmful chemicals from contacting the skin. The soft, napped surfaces cannot scratch plates and may be washed when dirty. Two styles to choose from.



PART #	DESCRIPTION
MIS-DP3M	3M Developing Pad
MIS-DPAGFA	Agfa Developing Pad

Automask Masking Film

PART #	GAUGE	COLOR	SIZE
AUT-R00340150	.003"	Ruby	40" x 150"
AUT-R00340300	.003"	Ruby	40" x 300"
AUT-R00540150	.005"	Ruby	40" x 150"
AUT-R00540300	.005"	Ruby	40" x 300"
AUT-A00340150	.003"	Amber	40" x 150"
AUT-A00340300	.003"	Amber	40" x 300"
AUT-A00540150	.005"	Amber	40" x 150"
AUT-A00540300	.005"	Amber	40" x 300"

autotype



James Burn Plate Punches

A "must" when using roll-fed plate materials or polyester laser plates

Use for punching paper, polyester and metal offset plates. Made by the leading manufacturer of offset plate punches, these very durable, precision units offer years of service.

- Keeps plates straight to improve registration for better print quality
- Punches feature an extended register pin for punching wider plates

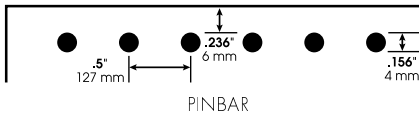

PART #	DESCRIPTION
MIS-JBOP25	12½" Pinbar Punch
MIS-JBOPS361	18" Pinbar Punch

Lithco Vacuum Frame Contact Boards

Provides the uniform contact surface necessary to ensure the best quality film and plate exposures in your vacuum frame. Made of .035" thick vinyl, black matte two sides. Not punched to accommodate variations in pin register systems.

- Assures uniform emulsion-to-emulsion contact
- Absorbs light
- Accepts and releases tape perfectly



PART #	DESCRIPTION
CON-2024	20" x 24"
CON-2538	25" x 38"
CON-3040	30" x 40"
CON-4050	40" x 50"
CON-4060	40" x 60"
CON-5060	50" x 60"
CON-511/273	51½" x 73"



Stouffer Platemaker's 21-Step Gray Scale

21-Step transparent scale for plate making, contact printing and photo processing. Steps are progressively more dense in increments of 0.15. Made in accordance with GATF specifications.

PART #	DESCRIPTION
MIS-SGSP21	Platemaker's 21-Step Gray Scale



Carbon Arcs

The manufacturer of these high intensity carbon arcs is certified ISO 9002 for quality assurance. Each lot is burn tested to insure that rods are uniform in light output so you get the optimum plate image for longer runs.

PART #	SIZE	DESCRIPTION
MIS-CA76	7 mm x 6"	Carbon Arcs
MIS-CA87	8 mm x 7"	Carbon Arcs
MIS-CA88	8 mm x 8"	Carbon Arcs
MIS-CA98	9 mm x 8"	Carbon Arcs
MIS-CA1012	10 mm x 12"	Carbon Arcs
MIS-CA118	11 mm x 8"	Carbon Arcs

PlateStrips®



Allows paper and polyester plates to run like metal

PlateStrips offers the users of disposable printing plates the luxury of running tight register, multi-color work without the added cost of film, stripping and metal plates. They virtually turn your disposable plates into metal.

- Use on paper or polyester Silvermaster, laser or electrostatic plates
- Easy to use – peel off the protective backing, adhere to lead edge of the plate and punch
- Special adhesive resists fountain solutions and press solvents
- Eliminate tearing and stretching of pinbar holes
- One size fits disposable printing plates up to 14" wide
- Available in convenient 25 strip pack or economical 100 strip tubes

PART #	QTY/PKG	DESCRIPTION
MIS-PS	100	PlateStrips
MIS-PS25	25	PlateStrips



PEEL



PRESS



PUNCH



RUN

BASE-LINE MASKING MATERIALS

Base-Line Masking Sheets

The original and still **THE BEST**

Since 1948, Base-Line has provided labor saving pre-ruled masking materials based on press manufacturer specifications. Base-Line's industry standard 1/4" grids and unique reference marks enable accurate film positioning and reduce re-makes caused by stripping errors.

- Printed one-up on oversized stock, then trimmed to extremely precise dimensions
- Masking sheets have consistent, smooth surfaces
- Quality, coated paper ensures resistance to kinking and tearing
- Free from pinholes and irregularities
- Cuts are smooth and precise



- Materials (goldenrod, orange and mandarin papers) block all undesirable spectrums of light while offering ample translucence
- Available in imperial (U.S.) or metric ruling

Pre-Ruled Orange Vinyl Masking Sheets

Provides added dimensional stability for color stripping and archivability

Base-Line's newest product combines the industry standard 1/4" grid with a vinyl substrate that increases stability in changing environmental conditions. Manufactured to the same exacting standards as their paper mask, the grids are identical for easy use and come pre-cut to fit your plates.

- Provide additional archival strength
- Excellent tape release properties



Base-Line also manufactures the **Kelly TRU-LINE®** brand of pre-ruled masking sheets.



For a complete listing of all Base-Line products, including sizes and part numbers, visit our weblink #P561.



Other Base-Line Products may be found on the following pages:

- Laser Direct Plates – page 37
- Opaque Pens – page 53
- Pressroom Chemicals – page 57
- Jomac Brand Dampening Covers – page 74
- REL and Base-Line Correction Pens, Clean-up Sheets – page 75
- Jomac Brand Gloves and Safety Products – pages 102-103



New products coming soon. Click on weblink #P562.

Base-Line Prepress Plastics

Package-to-package consistency guarantees satisfaction

Top quality, dimensionally stable plastics are available in a wide assortment of sizes and gauges, and come in standard or custom cut sizes.

MATERIALS AVAILABLE:

- Orange Vinyl Masking
- Clear Polyester
- Anti-Static Polyester
- Anti-Newton/Anti-Halo Polyester
- Ruby and Amber Peelable Masking

ALL BASE-LINE MATERIALS ARE:

- Graphic arts grade
- Exceptionally strong, resist tearing
- Trimmed to exacting standards
- Packaged for easy handling
- Sheets are temperature resistant to reduce shrinking, stretching and rippling



The Base-Line Worry-Free Warranty

Base-Line backs every product we sell with an absolute guarantee for quality, value, reliability and excellent customer service. If you are not satisfied with the performance of any Base-Line product, we will replace it or refund your money.



Note: All Base-Line products are available from Lithco. Contact your dealer or Lithco Customer Service for additional product details and for size specifications and part numbers.

Base-Line Reactive Cross Linking Fountain Solution



Winner of the prestigious GATF Intertech Technology Award

Formulated for use with metal and silver plates, RCL can be used for duplicators, sheet-fed and web presses. RCL's patented formula incorporates a catalyst to promote "cross linking" of the ink to the printing substrate.

- Cuts drying time as much as 50%
- Eliminates ink set-off
- Simplifies ink-water balance
- Elimination/reduction of isopropyl alcohol and fountain solution additives
- Compatible with all inks, plates and printing substrates
- Reduces need for spray powder
- Higher gloss levels and sharper colors
- Biodegradable, no flash point, no heavy metals

Total Release Compound™

An ink additive that improves the transfer of ink from the blanket to the press sheet

Yield more consistent solids with reduced voids, shading, ghosting, hickeys and picking.

- Enhances oil, soy, rubber, acrylic laser/thermal, UV and metallic inks
- Compatible with overprint varnish

Back Cylinder Ink Preventer

A convenient spray-on coating for your impression cylinder

Simply clean the surface with a cylinder cleaner, wipe the surface with a damp cotton pad or rag, dry, and spray on Back Cylinder Ink Preventer.

- Provides a protective film to help prevent future ink build-up on your cylinder
- Eliminates costly downtime

Farlux Gel

An ink additive to promote faster drying

Farlux Gel will not cause the ink to set-up in the fountain.

- Works with oil, soy, acrylic, laser/thermal, rubber and metallic inks, and in overprint varnish
- Assists ink drying from the bottom up and the top down

Laser Direct Starter

A universal etch and fountain solution

Laser Direct works on all silver-based, metal, electrostatic plates and dry toner laser plates.

- Superior wetting agents keep screens and fine lines open
- Provides the necessary latitude to perform on all plates and dampening system configurations



See page 37 for Baseline Laser Direct Plates.



Maticlean

Cleaner and conditioner for metering rollers

For use in continuous dampening systems.

- Quickly cleans and conditions fountain pick-up and transfer rollers
- Desensitizes rollers to ink
- Use on chrome, rubber, nylon, ceramic and all other metering rollers

Formula 86

A fountain additive for all dampening systems

Formula 86 reduces or eliminates the need for alcohol in the fountain. It delivers sharper halftones and a smoother lay of ink.

- Faster drying time
- Environmentally conscious...lowers VOC emissions

Laser Direct Plate Cleaner*

Safely removes ink particles from all types of plates

Desensitizes non-image areas.

- Makes the print area more receptive to ink
- Use regularly to prevent plate oxidation
- Prepare plates for storage

*Formerly "Sure Plate Cleaner"

Magic!

A silver plate starter that cleans and conditions

Designed specially for use on all silver-based, photo-direct plates.

- Print sharper lines and halftones while reducing toning and scumming
- Allows for the fastest silver plate startup available with the least amount of roll-up sheets
- Works like "Magic!"

PART #	SIZE	DESCRIPTION
BAS-RCLG	Gallon	Reactive Cross Linking Fountain Solution
BAS-TRC0014	1.4 oz.	Total Release Compound*
BAS-TRC0024	24 oz.	Total Release Compound*
REL-200415	1.4 oz.	Back Cylinder Ink Preventer (Aerosol)
REL-1008	8 oz.	Farlux Gel
REL-1016	16 oz.	Farlux Gel
REL-14101	Quart	Laser Direct Starter
REL-14103	Gallon	Laser Direct Starter
REL-222611	Quart	Maticlean
REL-222613	Gallon	Maticlean
REL-610301	Quart	Formula 86
REL-610303	Gallon	Formula 86
REL-220701	Quart	Laser Direct Plate Cleaner
REL-220703	Gallon	Laser Direct Plate Cleaner
REL-221059	Pint	Magic!
REL-221103	Gallon	Magic!

* Note: Also available in 6 lb., 12 lb., 30 lb. and 350 lb. containers.



WASHES and CLEANERS



Press chemistry that works...and won't break the bank!



Lithco Duplicator Blanket & Roller Wash

This fast drying wash designed for small offset presses quickly cuts ink. There is no oily residue, so it can be used in automated wash-up attachments. The flash point is over 100° F. Contains no chlorinates.

Lithco Fast Dry Wash

Our long-time favorite wash

Our most popular blanket and roller wash is now even better. It has been improved to help comply with environmental standards. Contains no chlorinates, dries quickly and deep cleans rubber surfaces for longer blanket and roller life.

Lithco Extra Fast Dry Wash

If you want fast, this is your ideal choice!

Our fastest drying wash is designed for duplicator presses requiring fast turns between jobs. The special blend of solvents really cuts ink fast, improving overall efficiency. This formula contains no chlorinates.

Lithco WM Wash

A water miscible wash designed for medium sized presses

Rejuvenates as it cleans. Can be mixed with up to 25% water to remove gum glaze, paper piling and spray powder. Flash point is over 100° F.

- Does not contain any chlorinated hydrocarbon solvents
- Good drying speed



The most efficient way to do a color change is with a two-step wash.

Lithco Step One Roller Wash

A special blend of solvents, surfactants and water creates an unbeatable formula that deep-cleans and deglazes rollers. Designed for quick, efficient color changes. Flash point over 100°F.

Lithco Step Two Roller Wash

Designed to quickly and efficiently flush residual Step One from rollers. It's the perfect blanket wash for medium to large presses. Flash point over 100° F.

Lithco Isopropyl Alcohol 99%

Use as a wetting agent in fountain solutions to prevent toning.

Lithco MRC

This Metering Roller Cleaner is highly effective in cleaning and desensitizing the water metering roller on continuous dampening systems. Will not contaminate fountain solution.

Lithco Deglazer

A powerful solvent for removing the toughest ink, varnish and friction glazes. Rejuvenates as it cleans.

Lithco Glass Cleaner

This is no wimpy glass cleaner

This powerful cleaner cuts through dirt on glass, plastic and metal surfaces. Removes dirt, grease, tape adhesive and fingerprints. Caution: not recommended for camera lenses.

Lithco Film Cleaner

Silver halide, lith-film cleaner

A fast drying cleaner that is unbeatable in removing tape, paste-up wax, fingerprints and dirt. Not for use on color negatives, transparencies or magenta contact screens.

WASHES & CLEANERS

PART #	SIZE	DESCRIPTION
CHM-DUPG	1 Gallon	Duplicator Blanket & Roller Wash
CHM-DUP5	5 Gallon	Duplicator Blanket & Roller Wash
CHM-FDG	1 Gallon	Fast Dry Wash
CHM-FD5	5 Gallon	Fast Dry Wash
CHM-EFDG	1 Gallon	Extra Fast Dry Wash
CHM-EFD5	5 Gallon	Extra Fast Dry Wash
CHM-WM5	5 Gallon	WM Wash
CHM-S1G	1 Gallon	Step One Roller Wash
CHM-S15	5 Gallon	Step One Roller Wash
CHM-S2G	1 Gallon	Step Two Roller Wash
CHM-S25	5 Gallon	Step Two Roller Wash
CHM-DEGG	1 Gallon	Deglazer
CHM-DEG5	5 Gallon	Deglazer
CHM-IPAG	1 Gallon	Isopropyl Alcohol
CHM-IPA5	5 Gallon	Isopropyl Alcohol
CHM-MRCG	1 Gallon	Metering Roller Cleaner
CHM-MRC5	5 Gallon	Metering Roller Cleaner
CHM-GCG	1 Gallon	Glass Cleaner
CHM-FCG	1 Gallon	Film Cleaner

Enviro Blanket Restorer

The first major advance in blanket fixes

Formulated with the safety of both the pressman and the environment as foremost considerations. Swells blanket rubber more uniformly than conventional blanket fix. No harsh odor and low vapor pressure helps prevent drying in the jar.



- Free of cancer-causing methylene chloride
- Will not cause chemical burns
- Contains no ozone depleting chemicals

Lithco Pumice Powder Grade FFF

Removes even the toughest glaze from blankets and rollers

Combined with a soft cloth saturated with Lithco Deglazer, this pumice powder works fast and effectively eliminates glaze for the best cleaning results. Also recommended for polishing plates after deleting images with Lithco "Scotch" Hones (see page 89). Non-hazardous.



HANDY TIP

Lithco Wash-Up Bottles are the ideal way to dispense small quantities of solvent. They are graduated with ascending and descending scales to keep track of solvent usage for VOC reporting. See page 109.

Lithco Fountain "Stew"

Economical and safe to use... another Lithco "Best Buy"

Lithco Fountain "Stew" is a universal fountain solution for use on all metal, paper, plastic and photo-direct ("black") plates, regardless of the dampening system. It allows changing plates or ink without changing fountain solution. Low VOCs. Available in gallons. Inquire for availability of larger sizes.



Lithco Pure Gum Arabic 14° Baume

Use as a wetting agent in large press fountain solutions or dilute with water (1:1 Gum:Water) for preserving plates. Safe to use, it is non-hazardous and contains no VOCs.



PRESSROOM CHEMICALS

PART #	SIZE	DESCRIPTION
CHM-EBR	4 oz.	Enviro Blanket Restorer
CHM-FSG	Gallon	Fountain "Stew"
CHM-PGAG	Gallon	Pure Gum Arabic
CHM-PUM	1 lb.	Pumice Powder Grade FFF

Lithco Non-Offset Spray Powder

Each batch is quality-controlled to assure dependable and repeatable results

Our spray powder provides a smooth finish and is highly effective in preventing offsetting on a wide variety of stocks. Manufactured from the highest quality food-grade starch, it is acceptable for use on food wrappers. It contains no talc, clay or calcium carbonate. Excellent choice for coated label stock. Available in 2 lb. bags, and 10 or 50 lb. boxes in fine, medium-fine, and medium uncoated.



Gloves should always be worn when handling chemicals. See the Safety Section pages 104 and 105 for a selection of gloves.

PART #	WEIGHT	DESCRIPTION	PARTICLE SIZE
MIS-SPF2	2 lb.	Fine, Uncoated	17 to 23 micron
MIS-SPF10	10 lb.	Fine, Uncoated	17 to 23 micron
MIS-SPF50	50 lb.	Fine, Uncoated	17 to 23 micron
MIS-SPMF10	10 lb.	Medium-fine, Uncoated	24 to 27 micron
MIS-SPMF50	50 lb.	Medium-fine, Uncoated	24 to 27 micron
MIS-SPM10	10 lb.	Medium	34 to 38 micron
MIS-SPM50	50 lb.	Medium	34 to 38 micron

BURNISHINE PRODUCTS



FOUNTAIN SOLUTIONS

The Burnishine Products/Printers Pride fountain solutions set the standards against which others are judged. The entire product line has low VOCs and is **alcohol free**. All contain added wetting agents to prevent toning. Printers Pride fountain solutions run with less water, thereby increasing the ink drying speed and improving ink gloss. Their wide working latitude allows them to optimally function with all types of dampening systems, on all plate materials, with all inks. High dilution ratios make all these solutions economical to use.

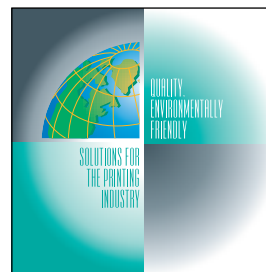

PART #	SIZE	DESCRIPTION	APPLICATION/FEATURES	DILUTION
PTZ-3457G	Gallon	Universal Fountain Solution	For all types of plates and dampening systems	1:15
PTZ-3459G	Gallon	Universal SM Fountain Solution	The best for Silvermaster, good with metal plates too	1:15
PTZ-3464G	Gallon	UFS SM Plus Fountain Solution	Works well with all metal and silver and laser plates, eliminates carbonless problems	1:32
PTZ-3476G	Gallon	Ultra Fount	Reduces or eliminates the need for alcohol with metal or silver and laser plates	1:32
PTZ-3460G	Gallon	Safety Fount	Non-toxic, non-flammable and biodegradable – works with metal, silver or laser plates	1:32
PTZ-3490G	Gallon	Laserfount	Formulated for laser plates	1:32
PTZ-3456G	Gallon	Non-Cyanic Electrostatic Etch & Fountain Solution	For electrostatic plates, does not crystallize	1:10-15
PTZ-3488G	Gallon	Non-Cyanic ES Plus	Eliminates problems with alkaline papers when running electrostatic plates	1:10-15
PTZ-3472G	Gallon	Alcohol Replacement	Eliminates the need for alcohol on all dampening systems	1:32

Note: Inquire regarding availability of five and fifty-five gallon drums.

SPECIALTY PRODUCTS

Thumbs Up®

Citrus hand cleaner for the professional printer

- Use with or without water to remove ink and grease
- Gentle to the skin



CRA-Z Soap®

A hard-bar hand cleaner for printers and lithographers

- Contains no petroleum or pumice, mild to the hands
- Lasts as long as two to three gallons of hand cleaner

PART #	SIZE	DESCRIPTION
PTZ-TUG	Gallon	Thumbs Up Hand Cleaner
PTZ-TUGD	Gallon	Thumbs Up Hand Cleaner with Dispenser
PTZ-CRAZ	Bar	CRA-Z Soap
PTZ-BCP	Pint	Epi-Safe Barrier Cream

Epi-Safe® Barrier Cream

Forms a protective film against harsh chemicals and dirt... softens hands

- Protects skin from irritation
- Non-greasy, non-irritating
- Protection lasts up to four hours



HANDY TIP

To assist you in the proper mixing and monitoring of your fountain solution, Lithco offers pH and Conductivity Meters, found on pages 82-84.

Blanket & Roller Cleaners



Putz Pomade®

This long time pressroom favorite rejuvenates and reconditions blankets and rollers

- Stops glazing and stripping
- Deep cleans for quick color changes
- Available in paste or liquid form

Clear Gel®

For those who prefer a non-abrasive roller and blanket cleaner

- Ideal for quick color changes (even black to yellow)
- Prevents stripping and glazing
- Deep cleaning action extends roller life

C.C.C.

Chrome cylinder & roller cleaner/desensitizer

- Prevents ink from sticking to chrome
- Increases chrome dampener efficiency
- Prevents oxidation
- Available in a web strength with extra cleaning power (Web C.C.C.)

Gold Miracle®

Scientifically developed to eliminate toning, scumming, scratches and paste-up marks

This starter, cleaner, conditioner and scratch remover for silver-based and laser plates sharpens halftones and fine lines. It gives longer, cleaner runs with black and colors. Non-flammable and biodegradable.

Plate Sav-Ur®

Removes scratches instantly

This cleaner and conditioner for metal offset plates removes scum, gum streaks and oxidation. It desensitizes plates for high-quality runs and conditions the plate surface to be more ink receptive. Excellent re-starter of standing plates. Non-flammable and biodegradable.

Aqua Blue®

Improves ink receptivity in image area

This cleaner, conditioner and scratch remover for aqueous plates removes scum, oxidation and gum streaks. Sharpens halftones for improved image quality.

Tone-A-Way®

Easily removes "toner scatter" without affecting the image area of the plate

This starter, cleaner and conditioner for laser plates provides sharper and brighter reproduction. For use on Laser Plates such as Lithco, Omega®, Pronto®, Technova®, Xante®, and Graphline®.

Plate Care®

Cleans and preserves all metal plates in one, easy step

This excellent plate storage solution provides superior protection against oxidation. Allows easy restarts of stored plates. May also be used as a plate finisher. Great for CTP and thermal plates.

Plate Products



PART #	SIZE	DESCRIPTION
PTZ-LIQ7	7 oz.	Putz Pomade Liquidflow
PTZ-LIQ13	13 oz.	Putz Pomade Liquidflow
PTZ-15	15 oz.	Putz Pomade Paste
PTZ-4	4 lb.	Putz Pomade Paste
PTZ-CG16	Pint	Clear Gel
PTZ-3462Q	Quart	C.C.C. - Chrome Cylinder & Roller Cleaner/Desensitizer
PTZ-3486Q	Quart	Web C.C.C.
PTZ-GMP	Pint	Gold Miracle
PTZ-GMQ	Quart	Gold Miracle
PTZ-GMG	Gallon	Gold Miracle
PTZ-PSP	Pint	Plate Sav-Ur
PTZ-PSQ	Quart	Plate Sav-Ur
PTZ-PSG	Gallon	Plate Sav-Ur
PTZ-ABQ	Quart	Aqua Blue
PTZ-TAQ	Quart	Tone-A-Way
PTZ-PCQ	Quart	Plate Care



HANDY TIP

Confused over which Burnishine Product is right for your needs? Contact Lithco for a FREE sample of any Burnishine chemical product along with technical assistance on using it correctly.

VARN PRODUCTS



Varn is a leading manufacturer of premium pressroom chemistry. The Varn line is quality controlled by infrared spectrophotometry and guaranteed to be uniform and to perform to your complete satisfaction.



ENVIRONMENTAL BLANKET & ROLLER WASHES

PART # *	U/M AVAILABLE	DESCRIPTION
VAR-ECx	2.5G, D	Ecolo-Clean – Homogenized, low VOC ecology wash (VOC=2.5 lbs.)
VAR-EC35x	2.5G, D	Ecolo-Clean 35 – Stronger homogenized ecology wash for larger presses (VOC=3.5 lbs.)
VAR-ECQDx	2.5G, D	Ecolo-Clean QD – Quicker drying, homogenized ecology wash for small presses (VOC=3.4 lbs.)
VAR-AC50x	G, 5, D	Airo-Clean 50 – Water miscible, meets current SCAQMD standard (VOC=3.6 lbs.)

WATER MISCIBLE BLANKET & ROLLER WASHES

PART # *	U/M AVAILABLE	DESCRIPTION
VAR-V120x	G, 5, 30, D	V-120 – Industry standard of premium, water miscible washes (Mix with up to 50% water)
VAR-V253x ¹	5, D	V-253 – Strong, fast drying water miscible wash (Mix with up to 30% water)
VAR-VWMx	G, 5, D	VWM – Strong, economical, water miscible wash (Mix with up to 50% water)
VAR-V60x ²	G, 5, D	V-60 – Flash point above 140°F (Mix with up to 50% water)
VAR-CWx	G, 5, D	California Wash – Water miscible wash (Mix with up to 30% water)

¹Böttcher Roller approved. ²M.A.N. Roland approved.

BLANKET & ROLLER WASHES

PART # *	U/M AVAILABLE	DESCRIPTION
VAR-CW1x	G, 5, D	Color Wash, Step 1 – Deep-cleaning, part one of the two-step color change system
VAR-CW2x	G, 5, D	Color Wash, Step 2 – Part two of the two-step system, flushes Step 1 from rollers, faster drying
VAR-DUPx	G, 5, D	Duplicator Wash – Outstanding small press wash (Flash point above 100° F)
VAR-PRONTOx	G, 5, 30, D	Pronto – Premium, fast drying press wash
VAR-V29955	5	V-2995 – Fast, economical small press wash
VAR-QCx	G, 5, D	Quick Clean - Extra fast drying small press wash
VAR-R7x	5, D	Wash R-7 - Economical, fast drying rubber and metal cleaner

SHEET-FED & SMALL WEB FOUNTAIN SOLUTIONS

PART # *	U/M AVAILABLE	DESCRIPTION
VAR-LE142Wx	G, 5, 30, D	Litho Etch 142W – Formulated for soft to medium water hardness
VAR-LE147x	G, 5, D	Litho Etch 147 – Formulated for hard water
VAR-TOTALx	G, 5, 30, D	Total – Traditional fountain solution for conventional dampening systems, speeds ink drying
VAR-TCFx	Q, G, 5, 30, D	Total Chrome-Free – Environmental formula, speeds ink drying
VAR-TPARx	Q, G, 5, 30, D	Total Plus-AR – Traditional formula, designed for IPA reduction
VAR-PK100x	G, 5, D	Pantheon K100 – Premium one-step fountain solution for Komori presses
VAR-PHD1x	G, 5, D	Pantheon HD1 – Part 1 of premium two-part system for Heidelberg presses
VAR-PHD2x	G, 5, D	Pantheon HD2 – Mix with Part 1 (HD1 and HD2 must be used together)



DUPLICATOR FOUNTAIN SOLUTIONS

PART # *	U/M AVAILABLE	DESCRIPTION
VAR-KAPx	Q, G, 5	Kompac All Purpose – Formulated for the Kompac dampener system
VAR-LE1000G	G	Laser Etch 1000 – Laser plate fountain solution
VAR-SLG	G	Super-Lene – Fountain solution for offset duplicators, all plates
VAR-UPG	G	Universal Pink – All plate, small press fountain solution
VAR-VERSIG	G	Versi – Universal solution for silver, black paper and metal plates

* x indicates unit of measure. Please specify when ordering. P = pint; Q = quart; G = gallon; 25 = 2.5 gal.; 5 = 5 gal.; 30 = 30 gal. drum; D = 55 gal. drum; 1 = 1 lb.; 45 = 4.5 lb.; 1K = 1 kilo; 11 = 11 lb.; 55 = 55 lb.

FOUNTAIN ADDITIVES

PART # *	U/M AVAILABLE	DESCRIPTION
VAR-GUMx	Q, G, 5, 30, D	Gum Arabic 14^o Be – 100% pure Sudanese gum Arabic, micro-filtered for purity
VAR-IPAx	G, 5, D	Isopropyl Alcohol – Fountain solution wetting agent 99% pure
VAR-JWx	G, 5, D	Jet Wet – Wetting agent which reduces the need for IPA
VAR-PARx	G, 5, D	PAR – Varn's unique alcohol replacement, contains no EB
VAR-SDP	P	Super Defoamer 225 – Highly concentrated additive to eliminate foam in continuous dampeners



SPECIALTY CHEMICAL PRODUCTS

PART # *	U/M AVAILABLE	DESCRIPTION
VAR-TBQ	Q	True Blue – Superior offset plate cleaner
VAR-PPx	Q, G	Plate Plus – Alkaline plate cleaner NEW
VAR-CPCQ	Q	NEW Complete Plate Cleaner – Compatible with all metal plates, great for CTP plates
VAR-BMx	Q, G	Black Magic – Asphaltum, gum and etch plate cleaner and storage
VAR-SLIPQ	Q	Slip Agent 6 – Silicone emulsion adds slip to metal parts
VAR-747x	Q, G	Compound 747 – Ink additive to reduce tack and improve lay
VAR-CPSQ	Q	Copper Plating Solution – Copper plate steel ink rollers, minimize stripping
VAR-DSCx	G, 5, D	Dampening System Cleaner – Prevents slime build-up, cleans hoses and tanks
VAR-FCx	G, 5, D	Film Cleaner – Cleans film, prevents static cling, no streaks
VAR-MRCx	G, 5, D	MRC – Metering Roller Cleaner, fast drying
VAR-ZAPx	G, 5, D	Zap – Premium metering roller cleaner, fast dry with no residue
VAR-ONITEQ	Q	OverNite – Industry's best blanket and roller deglazer works during downtime
VAR-REVx	Q, G	Revitol – Concentrated liquid blanket and roller deglazer
VAR-TTDx	Q, G	Triple Threat Deglazer – All-in-one deglazer removes calcium, water-soluble and solvent-soluble glaze NEW
VAR-PBR	8 oz.	Permanent Blanket Repair – Use as a pre-treatment to greatly reduce smashes
VAR-RLQ	Q	Roller Lube – Liquid lubricant and conditioner for idle roller trains
VAR-SRRx	G, 5, D	Super Rubber Rejuvenator – Deep cleans rubber, leaves like-new texture
VAR-SWELL	3 oz.	Swell – Topical blanket smash repair
VAR-TIOx	1, 45	Take It Off – Paste deglazer that removes ink and gum glazes
VAR-CEx	Q, G	Calcium Eliminator – Removes calcium build-up from rollers and blankets
VAR-PREVx	P, G	Prevent – Pump action ink anti-skinning spray



AEROSOLS

PART # *	U/M AVAILABLE	DESCRIPTION
VAR-AERAS	10 oz.	Anti-Static Spray – Stops static instantly
VAR-AERGC	15 oz.	Glass Cleaner – Cleans without streaks, anti-static formulation
VAR-AERIR	13.5 oz.	Ink-Readi – Ink anti-skinning spray
VAR-AERSS	9.75 oz.	Silicone Spray – Lubricant for metal surfaces



ANTI SET-OFF SPRAYS

PART # *	U/M AVAILABLE	DESCRIPTION
VAR-R20x	11, 55	R-20 Spray Powder – Very fine
VAR-R23x	1K, 11, 55	R-23 Spray Powder – Fine
VAR-R27x	11, 55	R-27 Spray Powder – Medium Fine
VAR-C230x	11, 55	C-230 Coated Spray Powder – Fine
VAR-C270x	1K, 11, 55	C-270 Coated Spray Powder – Medium Fine



* x indicates unit of measure. Please specify when ordering. P = pint; Q = quart; G = gallon; 25 = 2.5 gal.; 5 = 5 gal.; 30 = 30 gal. drum; D = 55 gal. drum; 1 = 1 lb.; 45 = 4.5 lb.; 1K = 1 kilo; 11 = 11 lb.; 55 = 55 lb.



The complete Varn line is available from Lithco.
If you do not see the specific product you require,
please contact our Customer Service Team for assistance.

PRESSROOM CHEMISTRY

Rosos Fountain Solutions

Rosos continues to lead the way as the manufacturer of the world's foremost fountain solutions by introducing new formulations for the future. Since its inception, Rosos has created fountain solutions that have always been on the cutting edge of environmental friendliness, operator safety and printing quality.



PART #	PRODUCT	SIZE	DESCRIPTION/APPLICATION
ROS-G7AVG	G7A-V Comb.	Gal.	General Purpose Etch
ROS-G7AV30D	G7A-V Comb.	30 Gal.	General Purpose Etch
ROS-726AVG	726 AV	Gal.	Bareback Dampening Systems
ROS-KSPG	KSP Plain	Gal.	Prevents Ink Emulsification
ROS-KSP500ASM3G	KSP 500ASM3	Gal.	Dahlgren or Duotrol Systems
ROS-KSP500ASM6G	KSP 500ASM6	Gal.	High Speed Webs, Extra Wetting Agents
ROS-RO50D3G	RO-50-D3	Gal.	Soft Water, Duotrol and Brush Dampening
ROS-RV1000G	RV 1000	Gal.	Alcohol Replacement
ROS-DGUMG	D Gum	Gal.	Desensitizing Gum
ROS-HNV1	HNV 1	Qt.	Plate Cleaner, Scratch Remover

NOTE: This is a partial listing of the wide variety of the most popular Rosos products available from Lithco.

J's Plate Kleen



Unique formula cleans metal plates, deglazes blankets

J's Plate Kleen is safe to use on most metal plates. Apply with a damp sponge, clean the plate and rinse.

- Removes gum streaks
- Removes surface scratches
- Cleans non-printing areas
- Removes semi-dried ink
- Makes image area more ink receptive
- To remove gum glaze from blankets, use same procedure as cleaning plates



PART #	SIZE	DESCRIPTION
CHM-JQ	Quart	J's Plate Kleen

Roller Mate



Unique, no-rinse formula protects idle unit rollers against friction

Roller Mate is the smoothest friction reducing lubricating compound available. Use it on "dead" printing units to prevent roller deterioration due to friction and heat build-up.

- Only a thin film is necessary to keep rollers lubricated
- Compatible with inks and varnishes – no rinsing or flushing required
- Apply to back cylinders to prevent color drag

PART #	SIZE	DESCRIPTION
CHM-ACRM11/2	1 1/2 lb.	Roller Mate
CHM-ACRM6	6 lb.	Roller Mate

Other AccuChem products are available. Please inquire.

Nacco Products Press Chemistry



PART #	DESCRIPTION	SIZE
NAC-824	Silverchem Activator – Excellent resolution, long lasting. Designed for use on Megalith™, Laser, Digital and Silvermaster™ type plates – Dilute 1:1	1 Gallon
NAC-811	Silverchem Stabilizer – Sharper images and long lasting – Dilute 1:3	1 Gallon
NAC-810	Silverchem Fountain Solution – Excellent results on Megalith, Laser, Digital, Silvertek™, Silvermaster and a variety of metal, paper and polyester based plates – Dilutes from 1:10 up to 1:30	1 Gallon
NAC-825	Silverchem Etch – Rapid-acting, non-flammable. Enhances ink receptivity and increases run length	1 Quart
NAC-310	Negative Plate Developer – Designed to be compatible with Anitec, Imation Viking, Kodak-Polychrome, IBF and similar plates – Biodegradable, consistent and reliable	1 Gallon
NAC-308	2n1 Negative Plate Developer – Formulated with gum Arabic, it offers the same features as NAC-310	1 Gallon



Spills happen when least expected. Be prepared with a spill kit designed to comply with OSHA and EPA requirements. See page 107.



See page 44 for Nacco darkroom chemistry and camera films.



WD-40 Lubricant

*The toolbox in a can –
Now in a large,
industrial size!*



WD-40 eliminates annoying squeaks and lubricates in hard-to-reach places. This unique formula creates an invisible barrier for excellent protection against rust and moisture. Penetrates rust to free-up frozen or rusted parts. WD-40 is a non-conductor so it can be used to dry out electrical and electronic equipment. Contains no silicones that form sticky residues. Spray bottle applicator is specially designed for the liquid.

PART #	DESCRIPTION
AER-WD4016	16 oz. Aerosol Can
CHM-WD40G	1 Gallon Liquid, Bulk
CHM-WD40SA	WD-40 Spray Bottle Applicator, Empty

Lithco One-Step Chain Cleaner & Lubricant with Teflon®

*Helps eliminate powder
build-up on
chains*



A unique lubricant and penetrating oil with Teflon® that works like magic on rusty chains, drill bits, paper cutter beds and noisy gears. Eliminates the sticky build-up caused by greases and silicone lubricants.

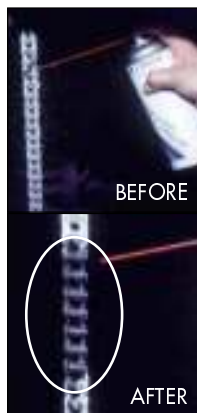

Lithco Hydraulic Oil

Available in two viscosity grades

Anti-wear hydraulic oils designed to give long service in high output hydraulic systems that use vane, piston or gear pumps. Contains zinc dithiophosphate anti-wear agent (not compatible with silver plated bearings). Non-corrosive to brass, bronze, steel and copper.

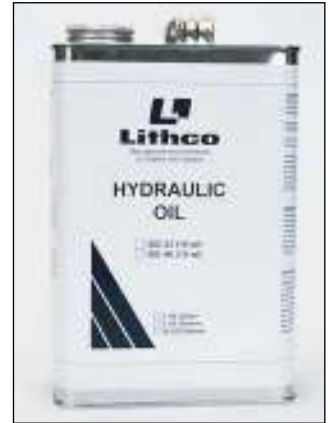

Lithco EP Grease

An extreme pressure grease with increased load carrying and anti-rust properties. Recommended for industrial applications that require extreme pressure protection in heavy or shock loading conditions.

Lithco Circulating Oil

Manufactured from carefully selected, premium quality, high viscosity index paraffinic base oils, and a combination of premium rust, corrosion and oxidation inhibitors. Features excellent water separation characteristics and low-foaming tendencies. Recommended for lubrication of plain and roller bearings, slides, machine tools and in low to normally loaded enclosed gear reducers.

Lithco EP Gear Oil

Formulated with premium, high viscosity index oils and a sulfur/phosphorous extreme pressure additive which contains no lead. Combats oil thickening and deterioration for long service life. Non-corrosive to bronze and bearing alloys. Excellent for use in oil-mist lubrication systems.

PART #	SIZE	VISCOSITY	DESCRIPTION
CHM-HO32G	1 Gallon Can	ISO 32	Hydraulic Oil
CHM-HO325	5 Gallon Pail	ISO 32	Hydraulic Oil
CHM-HO46G	1 Gallon Can	ISO 46	Hydraulic Oil
CHM-HO465	5 Gallon Pail	ISO 46	Hydraulic Oil
CHM-EPG14	14 oz. Tubes	NLGI #2	EP Grease
CHM-EPG35	35 lb. Pail	NLGI #2	EP Grease
CHM-COG	1 Gallon Can	ISO 220	Circulating Oil
CHM-CO5	5 Gallon Pail	ISO 220	Circulating Oil
CHM-EPOG	1 Gallon Can	ISO 68	EP Gear Oil
CHM-EPO35	35 lb. Pail	ISO 68	EP Gear Oil

STAY IN COMPLIANCE AND AVOID PENALTIES!
Get over 15,000 up-to-date MSDSs on line — including Lithco's.
Go to www.lithcoinc.com and click on link #C651 for more information.

- Spray on chains to remove rust, spray powder build-up and paper dust
- Apply to paper cutter bed instead of silicone to eliminate sticky build-up, remove rust, turn paper more easily
- Apply to drill bits to put a Teflon coating inside the bits for easier drilling, quicker chaff removal
- Especially effective in quieting noisy gears
- Extension tube provided for pin-point accuracy in hard-to-reach areas

PART #	DESCRIPTION
AER-CCLT	One-Step Chain Cleaner & Lubricant with Teflon, 11 oz.

AEROSOL SPRAYS & RUBBER CEMENT/THINNER



Sprayway

The most popular brand of graphic arts aerosols



- Specially formulated for prepress, press room and bindery
- Environmentally safe propellants – No ozone depleting chlorofluorocarbons
- A wide variety of choices to suit your specific needs

PART #	NET WT.	DESCRIPTION	APPLICATIONS
Graphic Arts Products			
SPR-40	15 oz.	Graphic Arts Glass Cleaner	All glass surfaces in prep department
SPR-203	13 oz.	Rubber Cleaner & Rejuvenator	Deglaze blankets and rollers
SPR-205	16 oz.	Film Cleaner	Removing fingerprints, tape and wax
SPR-206	9½ oz.	Specialty Film Cleaner	Safe on all film including diazo
SPR-945	11 oz.	Silicone Spray	Dry silicone stops sticking
SPR-950	14 oz.	Ink Anti-Skin Spray	Spray rollers, ink cans – prevent drying
SPR-955	14 oz.	Anti-Static Spray	Eliminates unwanted static electricity
Silk Screen Products			
SPR-80	20oz.	Web Type Adhesive Spray	Premium web adhesive spray
SPR-82	20 oz.	Mist Type Spray Adhesive	Economy pallet adhesive for textiles
SPR-83	20 oz.	Web Type Spray Adhesive	Economy pallet adhesive
SPR-84	20 oz.	Super Flash Spray Adhesive	Pallet adhesive for flash curing
SPR-208	12 oz.	Toner Aid	Enhances toner for silk screening
SPR-211	16 oz.	Adhesive Activator	Sets cyanoacrylate adhesives for quick bond
SPR-957	20 oz.	Instant Screen Opener	Opens dried inks in silk screening
Office and Computer Products			
SPR-45	16 oz.	Computer Screen Cleaner	Cleans and dissipates static
SPR-804	7 oz.	Lint and Dust Remover	Moisture-free air for delicate cleaning
SPR-805	12 oz.	Clean Jet 100	High-pressure canned air cleaning
Adhesives and Fixatives			
SPR-22	13 oz.	Spray Adhesive, Repositionable	Adheres to film without streaks
SPR-66	11 oz.	Spray Adhesive	Temporary or permanent bond
SPR-88	20 oz.	Multi-Purpose Spray Adhesive	Fast tack, long tack, high coverage
SPR-201	16 oz.	Clear Plastic Spray Fixative	Protect art and photographs
SPR-204	16 oz.	Matte Fixative	Matte coating on art and photographs
Lubricants and Cleaners			
SPR-63	16 oz.	Solvent Cleaner & Degreaser	Removes ink & grease
SPR-77	20 oz.	Silicone Lubricant	"Wet" silicone – prevent sticking
SPR-90	11 oz.	Machine Maintenance Spray	Lubricates, penetrates rust
SPR-101	16 oz.	TFE Dry Lubricant	Non-silicone release agent
SPR-715	16 oz.	White Lithium Grease	Heavy duty for gears and bearings
SPR-961	20 oz.	Hoil Penetrating Oil/Rustproofers	Penetrates rust, loosens frozen parts
SPR-985	19 oz.	Orange Citrus Crazy Clean	General purpose hard-surface cleaner

Best Test Rubber Cement

Designed to do one thing well...bond paper to paper



The industry's best since 1923.

Made from a specially blended and treated

formula of natural, white rubber. Will not curl, shrink or wrinkle. Provides either temporary or permanent bonds.

PART #	SIZE
CHM-138	4 oz. can, Brush in Cap
CHM-101	Pint Can
CHM-102	Quart Can
CHM-103	Gallon Can
CHM-104	5-gallon Pail



HANDY TIP

Bestine is a great adhesive remover. Use on art boards, photos, and lith negatives. Works great in removing pressure-sensitive labels from products.

Bestine Solvent and Thinner

Bestine is used for thinning or reducing rubber and paper cements. Updating or re-working an old job? Bestine is an excellent thinner for loosening old paste-up copy and removing adhesives. It can also simplify tough cleaning jobs on metal type, rollers and stencils.



PART #	SIZE
CHM-201	Pint Can
CHM-202	Quart Can
CHM-203	Gallon Can
CHM-204	5-gallon Pail

Lithco Non-Aerosol Ink Fresh™

Similar working properties as Ink Fresh Anti-Skinning Aerosol. Works better and lasts longer because it delivers 100% product to the ink. Packaged in a 16 oz. plastic pump bottle.



PART #	SIZE	DESCRIPTION
NAR-IF	16 oz.	Non-aerosol Ink Fresh™

Lithco BLAST!



All purpose duster

The quick, safe and economical way to easily "dust" electronic parts, lenses, keyboards and film. Many other uses around the home and workplace.



Lithco Aerosols



Lithco Aerosols have been an integral part of our product line since our founding in 1963. Today, our new, improved formulations are ozone-safe with no CFC propellants. These are as fine a product as you can find.



PART #	SIZE	DESCRIPTION	APPLICATION
AER-IF	12 oz.	Ink Fresh™ Anti-Skinning Spray	Prevents ink from skinning in cans and on rollers
AER-SG	11 oz.	Sun Glide™ Silicone Spray	Fast drying lubricant for use in pressroom and bindery
AER-AS	11 oz.	Anti-Static Spray	Eliminates static electricity, fast dry, non-staining
AER-GB	14.5 oz.	Glass Brite™ Glass Cleaner	Non-streaking formula cleans glass and plastic surfaces
AER-BLAST	7 oz.	BLAST! All purpose duster	Gently removes dust and lint from delicate surfaces

DUST-OFF®

"The Original" compressed gas duster

When Falcon introduced Dust-Off® more than twenty years ago, it was the first truly innovative method for keeping delicate equipment free of harmful dust and lint. Now, as the industry leader in environmental research and development, Falcon is proud to present the first complete line of 100% ozone-safe compressed-gas dusting products.



PART #	SIZE	DESCRIPTION	APPLICATION
DOF-FGS	10 oz.	Dust-Off 100% Ozone Safe with Chrome Nozzle	Your best choice for cameras, lenses, enlargers, computers, scanners, FAX machines and copiers.
DOF-FGSR	10 oz.	Dust-Off 100% Ozone Safe Refill	
DOF-FGVC	N/A	Dust-Off Chrome Nozzle	
DOF-DPS	10 oz.	Dust-Off Plus with Vector Valve	Features the patented 360° Vector Valve so you can aim the moisture-free dusting power where other dusters cannot reach.
DOF-DPSR	10 oz.	Dust-Off Plus Refill	
DOF-DPVC	N/A	Dust-Off Plus Vector Valve	
DOF-DPSXL	10 oz.	Disposable Dust-Off XL Can with Extension tube for Precision Dusting	Provides more blasting power per ounce than any other product of its kind. Utilizes a built-in integrated, disposable nozzle.
DOF-DPSJC	3.5 oz.	Disposable Dust-Off Junior with Extension Tube	Handy, compact disposable cans provide easy-to-carry, easy-to-store convenience. The ideal sizes for service technicians, photographers and graphic artists.
DOF-DPSMB	1.75 oz.	Disposable Dust-Off Mini Can	

BLANKETS

Lithco is a full-line Day International converter. We also convert our own brand of Lithco Premium Blue Blankets. Our expert technicians are trained to help you select the right blanket for your press. We convert blankets for all sheefed and web presses and finish them to manufacturers' specifications. Converting services include the following, as required:

- Cutting
- Barring
- Punching
- Bar Notching
- Skiving
- Bar Drilling



PRINTING BLANKETS

Lithco Premium Blue Blankets

The best blanket for the demanding jobs placed on today's press operator

The fully-compressible construction offers quick sheet release on coated stocks, even with heavy ink coverage.

- Uniformity of gauge assures quicker set-up
- Buffed surface carries better ink film for improved solids, even screens, and sharper halftones
- Resists smashes
- Facing resists cutting from cover stocks
- Solvent resistant construction prevents swelling and delaminating
- Rated a "Lithco Best Buy," Lithco Premium Blue blankets are sold satisfaction guaranteed or your money back.



DUPLICATORS



STRAIGHT CUT, PUNCHED, BARRED - ANY SIZE



This is just a short list of blankets available in Premium Blue. Premium Blue is available in all press sizes. Supply dimensions for any press.

PART #	PRESS	SIZE - INCHES	PART #	PRESS	SIZE - INCHES
A.B. Dick 3-Ply			Hamada 3-Ply		
PB3ABD360	360	18½ x 10 ⁵ / ₈	PB3HAM600	600/660	19 ¹ / ₈ x 12
PB3ABD36011	360-11"	18½ x 11	PB3HAM700	700/770	16½ x 18 ³ / ₈
PB3ABD9800	9800	19 ³ / ₁₆ x 12 ⁵ / ₈	PB3HAM800	800/880	16 ¹¹ / ₃₂ x 20¼
PB3ABD98003/8	9800	19 ³ / ₈ x 12 ⁵ / ₈	Heidelberg 4-Ply		
ATF - Chief 3-Ply			PB4HEIDTOK	TOK, TOM ¹	16 x 10½
PB3ATF15	15	15 ³ / ₁₆ x 10	PB4HEIDGTO46	GTO46 ²	17 ⁵ / ₁₆ x 18½
PB3ATF17	17	18 ⁸ / ₁₆ x 10 ³¹ / ₃₂	PB4HEIDGTO52	GTO52 ²	17½ x 20½
PB3ATF2217	2217	19 ¹³ / ₁₆ x 12 ⁵ / ₈	PB4HEIDQM	Quickmaster ³	21 ⁷ / ₈ x 13¼
AM Multigraphics 3-Ply			Ryobi - 5-Ply		
PB3M1250	1250	15 ⁵ / ₁₆ x 10	PB5KR2800	KR2800	19 x 11¼
PB3M1250W	1250W	18½ x 10 ⁵ / ₈	PB5KR3200	KR3200	19½ x 12
PB3M1250W11	1250W-11"	18½ x 11	PB5KR3302	KR3302 ³	19½ x 13
PB3M1360	1360	18 ⁷ / ₁₆ x 12 ⁵ / ₈			
PB3M1850	1850/1860	16 ¹ / ₁₆ x 17 ⁵ / ₈			

¹ Supplied straight cut; ² Supplied straight cut, aluminum lock-up bars available;

³ Aluminum lock-up bars supplied on these blankets

xyz Specify press name and model, around by across dimension, and indicate finishing requirement such as straight cut, punched or barred

PART #	DESCRIPTION
For sizes not listed	
PB3xyz	Premium Blue 3-Ply
PB4xyz	Premium Blue 4-Ply
PB5xyz	Premium Blue 5-Ply



REEVES Brothers Printing Blankets

- Vulcan Reflection SRF
- Vulcan 2000 Plus SR
- Vulcan 2000 Plus
- Vulcan 714



When ordering from your dealer, it is important to accurately specify blanket dimensions AROUND X ACROSS to ensure proper grain direction on the press.

DAY INTERNATIONAL BLANKETS

dayGraphica® PRINTING BLANKETS



Day International's line of dayGraphica lithographic offset printing blankets has provided solutions to printers for more than 50 years. Day is the innovative market leader in manufacturing quality printing blankets worldwide.

dayGraphica 3000

For heatset, non-heatset web and sheetfed presses

The precisely ground finish of the 3000 provides superior surface smoothness and gauge uniformity which provides maximum sheet release and excellent print fidelity. The patented, closed-cell compressible layer produces precise, even pressures across the entire printing surface. The printing face compound is completely compatible with today's ever-changing pressroom chemistries. The 3000 is a world-class performer in waterless printing. Available in 3- and 4-ply. Color: Blue.

dayGraphica 8212

For sheetfed, folding carton, metal decorating and plastics

The 8212 is an all-purpose, cast surface, conventional blanket which provides super-quick release, eliminating sheet curl and providing maximum ink coverage with minimal dot distortion. The split-face construction maximizes resiliency and stability in a variety of printing applications. The printing face compound is also compatible with today's evolving pressroom chemistries. Available in 2-, 3-, 4- and 5-ply. Color: Blue.



The only accurate way to check packing on a press is with a Trupak Blanket Packing Gauge. See page 70.



P
R
E
S
S
R
O
O
M

dayGraphica 4000



For improved durability on modern heatset web presses

The dayGraphica 4000 gets you up to color fast and keeps you in register. Reduces costly downtime and paper waste due to smashes, feed problems and web breaks. Its tough, ground surface lets you switch paper stock with less concern about edge cutting while providing proper print density in light or heavy coverage areas. The 4000 resists gauge loss to help you print to the gap. Enhanced compressible zone improves rebound from web breaks and smashes. Available in 3- and 4-ply. Color: Dark Purple.

dayGraphica 8300



Eliminates on-press static electricity problems

This unique, newly designed surface compound eliminates static electricity problems on the press. The highly ground and buffed surface produces uniform gauge and consistency, ideal ink transferring characteristics and maximum ink release. The patented, closed-cell compressible layer enables the blanket to achieve precise and even printing pressure across the entire printing surface, allowing instant rebound. Available in 4-ply. Color: Black.

- Compatible with waterless plates
- Designed for digital direct-to-press imaging systems

dayGraphica 8500

For heatset, non-heatset web and sheetfed presses

The 8500 is a cast surface compressible blanket that continues to be the workhorse of printing blankets for all varieties of printing applications. The cast surface finish reduces solvent penetration, prints pinhole-free solids and sharp dots. The patented closed-cell compressible layer achieves precise, even print pressures across the entire print surface. Available in 3- and 4-ply. Color: Blue.

- Completely compatible with today's environmental chemistries
- Extremely effective on lightweight paper stocks, non-alcohol fountain solutions and fast drying inks
- Also available in 8700 5-ply for use on Ryobi presses. Color: Green

dayGraphica 9500

For heatset, non-heatset web and sheetfed presses

The 9500 is a world-class performer. The exclusive patented "texturized" printing surface combines consistent ink transfer with quick sheet release. The surface is 100% talc-free which dramatically cuts make-ready and wash-up times. The patented closed-cell compressible layer provides precise, even pressures across the entire printing surface. The 9500 also has proven successful in waterless printing systems. Available in 3- and 4-ply. Color: Plum.

PLEXUS PRECISION GAUGES



TRUPAKflex Magnetic Packing Gauge

Designed for the serious printing professional. The flexible arm design allows the user to make accurate blanket measurements on a wider variety of presses and conditions. Optional interchangeable arm permits measurements on presses with bearer guards and other obstacles. Arm length adjustable for wide gutters and undercut blankets.



Blanket Packing Gauges from Plexus Pacific



Choose from the following Plexus TRUPAK™ gauges to meet your specific shop requirements.

Maximize print quality

Use these gauges to measure packing of your blanket cylinders. Reduce dot gain, problems from overpacking, and wear on plates and cylinder bearings. Measures on press without damage to the blanket or plate. All gauges are manufactured in the USA and come with a **lifetime** "no-fault" warranty. An essential TQM tool with the following features:

- Twin-radius contact rails for ease of alignment on the cylinder
- State-of-the-art Delrin body prevents scratching
- Accurate to better than .001" or .02 mm
- Precision machined to aerospace tolerances
- Housed in hand-crafted wooden storage boxes

TRUPAK Blanket Packing Gauge

The original, with all of the above features, is designed to provide you with affordable accuracy. Works on most presses with bearers.

TRUPAK Plus Magnetic Packing Gauge

A magnetic version of the popular TRUPAK blanket packing gauge. Trupak Plus has all of the features of the original, PLUS the added feature of "self-locking" to the blanket cylinder for hands-free operation. Designed for presses over 25" with bearers. Not compatible with aluminum or alloy cylinders.

TRU>TEST™ Durometer



A durometer is used to measure the hardness of "soft" surfaces such as printing rollers. Regular use of a durometer detects bad printing rollers before they cause print quality problems. Old rollers that have been used in alcohol dampening systems for extended periods of time may have become too hard to function properly. Use this simple, accurate device to determine if excessively hard rollers are causing your problems.

PART #	DESCRIPTION
EQP-PLD	TRU>TEST Durometer

PART #	DESCRIPTION	SCALE	APPLICATION
EQP-TP	TRUPAK Blanket Packing Gauge	Inches	Small Presses with Bearers
EQP-TPM	TRUPAK Blanket Packing Gauge	Metric	Small Presses with Bearers
EQP-TPP	TRUPAK Plus Magnetic Packing Gauge	Inches	Medium Size Presses with Bearers
EQP-TPPM	TRUPAK Plus Magnetic Packing Gauge	Metric	Medium Size Presses with Bearers
EQP-TPF	TRUPAKflex Magnetic Packing Gauge	Inches	Large Presses with Wide Gutters
EQP-TPFM	TRUPAKflex Magnetic Packing Gauge	Metric	Large Presses with Wide Gutters
EQP-TPFA	TRUPAKflex HiReach Arm (optional)	—	Medium Size Presses with Bearer Guards



Other great products from Plexus Pacific are MIKE-EZ on page 28 and EZ-Skid on page 87.

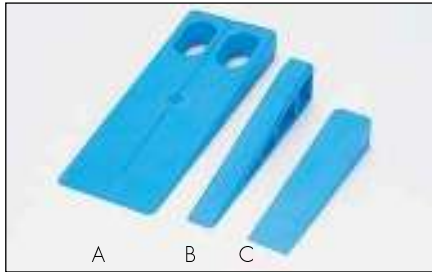

Pile Separators

Smooth, thin lead edge allows for easy insertion in stack without damaging stock

Pile Separators, or Paper Wedges, are used to assure accurate leveling of paper stock piles. Use on feeder end for positive pick-up and delivery end to assist in proper jogging.

- Longer taper permits closer adjustments
- Made of high-impact styrene for longer life
- Will not soak-up oils, ink or dirt
- Three sizes handle duplicators to large sheetfed presses

PART #	PHOTO	SIZE
LIT-PPSA	A	1" x 7 ³ / ₄ " x 3"
LIT-PPSB	B	1 ³ / ₈ " x 6" x 3 ¹ / ₄ "
LIT-PPSC	C	7 ⁷ / ₈ " x 4 ⁷ / ₈ " x 1 ¹ / ₈ "

Polyester Press Packing Sheets

- **Adhesive-Backed (AB)**
- **Regular Polyester**

A must for quality-minded printers, polyester press packing sheets compensate for variations in blanket, plate and paper stock thicknesses. Polyester sheets are durable and exhibit dimensional stability. The adhesive backing facilitates mounting and is resistant to press chemicals. Regular Polyester is sold in packages and available in 24" x 36", 36" x 48" and custom sizes. AB sheets are available individually in custom sheet sizes up to 48" wide. Gauges available:

.001 ¹	.004 ²	.007 ²	.010 ²	.016 ³
.002 ²	.005 ²	.008 ³	.012 ³	.018 ³
.003 ²	.006 ³	.009 ³	.014 ³	.020 ³

¹ Standard only; ² Standard or AB; ³ AB only.



LITHCO CLEAN-UP SHEETS

The quick, economical way to clean your ink rollers. Available in sizes to fit popular duplicator and small presses. Made from an extra heavy-duty stock, they possess superior wet strength and absorbency. Usable on two sides for added economy. Virtually lintfree.

- Styles available are pinbar, slotted and straight edge
- Packaged 100 sheets/box

Lithco Clean-Up Sheets are available for all duplicator models of the following presses:

- | | | |
|--------------------|-------------------|-------------|
| ➤ A.B. Dick | ➤ Hamada | ➤ Rotaprint |
| ➤ AM/Multigraphics | ➤ Imperial | ➤ Ryobi |
| ➤ A.T.F. | ➤ Itek | ➤ Toko |
| ➤ Davidson | ➤ Miehle - M.G.D. | |

Note: Contact your dealer or Lithco Customer Service for additional product details, size specifications and part numbers for individual presses.



Riegel Paper Presspak

Each sheet is marked with the caliper (gauge) and grain direction

Sheets are coated for dimensional stability. Available in a wide range of gauges — .003" to .012", and .015" — for packing both blankets and plates.

- Supplied in convenient packages of 100 sheets
- Custom cut to your size requirements

Note: Order AROUND x ACROSS, with the grain running across the press cylinder.

H.S. BOYD

H.S. BOYD OFFSET RULES *We are the Perf People*

Why give profits away? Keep profits where you want them — in house. H.S. Boyd Offset Rules attach to the impression cylinder of the press and enable the operator to perf, score, slit and punch on-press — while you print! Quality manufacturing steps provide you with products you can count on to perform consistently. This translates into lower costs and higher quality for your clients.

- Heat-treated for strength
- Sharpened with diamond-wheel sharpeners
- Available in the original Side Series (SS) or Center Series (CS) for increased pressure and longer runs
- Available in a variety of configurations for a multitude of applications



Go to web link #P721 to request your free H.S. Boyd Guide to Perforating.

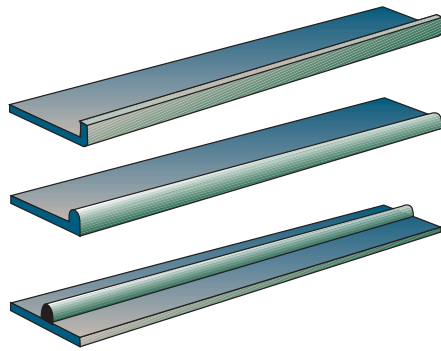

Litho-Perf — SS & CS

The original and still the world standard for reliability and high-quality performance

Litho-Perf is available in 6-, 8-, 12-, and 16-tooth blades with height selections from .0125 inch to .029 inch, allowing you to perform perforations on a wide variety of different paper and card stocks. Perfect for jobs like direct response mailing cards, coupon booklets, and raffle tickets. Litho-Perf/CS is the only center-mounted rule available that is heat-treated using Boyd's time-tested methods for extended life.

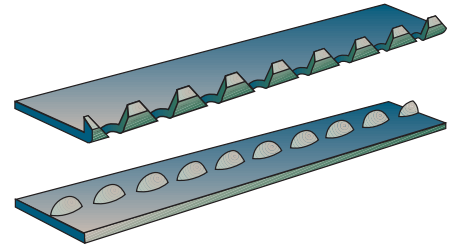

Litho-Score — SS, SSR, & CS

The first in-the-run, on-press scoring accessory designed for the offset press. Litho-Score holds consistent register with the printed copy. The rule prepares the stock for a more precise fold and is available in various heights for card and paper stocks. Litho-Score is ideal for scoring newsletters, folders, thank-you cards, announcements and table tents. The scoring edge on SSR and Center Series is rounded to prevent surface cracking on cast-coated stock, or when scoring through heavy, solid ink coverage.

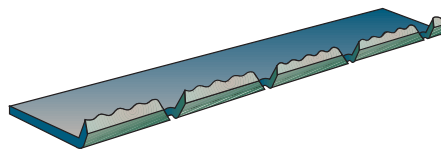

Litho-Snap — SS

The economical answer to snap-apart forms printing

Litho-Snap functions in the same manner as Litho-Perf, creating perforated, quick separation snap-out or snap-apart forms. Available in 3-, and 4-tooth blades.

LITHO-PERF — SS & CS

SIDE SERIES PART #	CENTER SERIES PART #	LENGTH	SIDE SERIES PART #	CENTER SERIES PART #	LENGTH	TEETH/ INCH	APPLICATION
BOY-800	BOY-600	10 ft.	BOY-808	BOY-608	20 ft.	6	Paper
BOY-801	BOY-601	10 ft.	BOY-809	BOY-609	20 ft.	6	Card
BOY-802	BOY-602	10 ft.	BOY-810	BOY-610	20 ft.	8	Paper
BOY-803	BOY-603	10 ft.	BOY-811	BOY-611	20 ft.	8	Card
BOY-804	BOY-604	10 ft.	BOY-812	BOY-612	20 ft.	12	Paper
BOY-805	BOY-605	10 ft.	BOY-813	BOY-613	20 ft.	12	Card
BOY-806	BOY-606	10 ft.	BOY-814	BOY-614	20 ft.	16	Paper
BOY-807	BOY-607	10 ft.	BOY-815	BOY-615	20 ft.	16	Card

LITHO-SCORE — SS, SSR, & CS

SIDE SERIES PART #	CENTER SERIES PART #	LENGTH	APPLICATION
BOY-826	BOY-626	10 ft.	Paper and Lightweight Card Stock
BOY-8263	BOY-6261	10 ft.	Cast Coated & Heavy Card Stock (SSR)
BOY-827	BOY-627	20 ft.	Paper and Lightweight Card Stock
BOY-8273	BOY-6272	20 ft.	Cast Coated & Heavy Card Stock (SSR)

LITHO-SNAP — SS

SIDE SERIES PART #	LENGTH	SIDE SERIES PART #	LENGTH	TEETH/INCH	APPLICATION
BOY-820	10 ft.	BOY-821	20 ft.	3	Paper
BOY-822	10 ft.	BOY-824	20 ft.	4	Paper
BOY-823	10 ft.	BOY-825	20 ft.	4	Card



For the ultimate in-line perforating and scoring, see page 121 for the Perf, Print, Plus (PPP) System from H.S. Boyd.

Micro-Perf — SS

With 30-, 40-, and 50-tooth blades, Micro-Perf is ideal for perforating continuous-feed forms; it creates a perforation line that remains clean.

The blades are available in a blade height of .022", designed for use on paper or lightweight card stocks. Perfect for jobs that pass through a laser printer after being perforated.

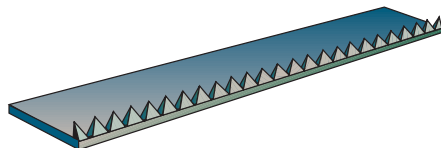

PART #	LENGTH	PART #	LENGTH	TEETH/INCH	APPLICATION
BOY-300	10 ft.	BOY-301	20 ft.	30	Paper and Lightweight Card Stock
BOY-400	10 ft.	BOY-401	20 ft.	40	Paper and Lightweight Card Stock
BOY-500	10 ft.	BOY-501	20 ft.	50	Paper and Lightweight Card Stock

Litho-Slit — SS & CS

Litho-Slit eliminates separate runs by permitting on-press, straight-cutting possibilities. The blade is effective for slitting, straight-line die cutting and insertion slots in presentation folders. Use on either card or paper stocks. Litho-Slit can be selected with either a straight edge knife edge, or a serrated edge to meet criteria for cleanliness of cut.

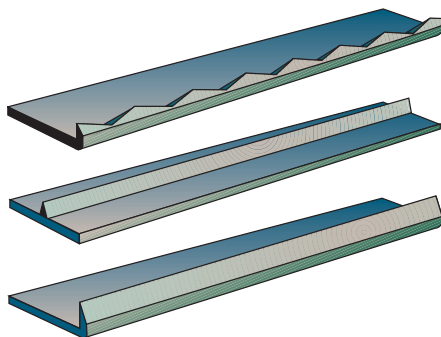

SIDE SERIES PART #	CENTER SERIES PART #	LENGTH	SIDE SERIES PART #	CENTER SERIES PART #	LENGTH	EDGE	APPLICATION
BOY-828	—	10 ft.	BOY-830	—	20 ft.	Serrated	Paper
BOY-829	—	10 ft.	BOY-831	—	20 ft.	Serrated	Card
—	BOY-628	10 ft.	—	BOY-630	20 ft.	Straight	Paper
BOY-833	BOY-629	10 ft.	BOY-832	BOY-631	20 ft.	Straight	Card

Litho-Perf, Score and Slit Special Low and Special High — SS & CS

Thin and heavy stocks no longer present a problem in perforating, scoring and slitting. These specialty rules handle the job as easily as their standard counterparts.

SPECIAL LOW		SPECIAL HIGH			TEETH/		
SS PART #	HEIGHT	SS PART #	CS PART #	HEIGHT	LENGTH	INCH	TYPE
BOY-8000	.0125	BOY-8001	BOY-6001	.029	20 ft.	6	Perf
BOY-8002	.0125	BOY-8003	BOY-6003	.029	20 ft.	8	Perf
BOY-8004	.0125	BOY-8005	BOY-6005	.029	20 ft.	12	Perf
BOY-8006	.0125	BOY-8007	BOY-6007	.029	20 ft.	16	Perf
BOY-8011	.0125	BOY-8008	—	.029	20 ft.	4	Perf
BOY-8021	.014	BOY-8020	—	.021	20 ft.	16	Perf
BOY-8022	.015	—	—	—	20 ft.	12	Perf
BOY-8023	.016	—	—	—	20 ft.	8	Perf
BOY-8014	.0125	BOY-8012	—	.023	20 ft.	n/a	Score
—	—	BOY-8013	—	.019	20 ft.	n/a	Score
—	—	BOY-8015	—	.029	20 ft.	n/a	Score
—	—	BOY-8017	—	.029	20 ft.	n/a	Slit
—	—	BOY-8019	—	.029	20 ft.	n/a	Slit, Straight Cut

NOTE: Inquire about the availability of other heights and styles.

H.S. Boyd “How-To” Video - On Press Magic!

Takes the guesswork out of proper use of H.S. Boyd products

This comprehensive, eight minute video explains how to choose the right product, mount it on your press and run the job. Knowing how to use these products correctly will help increase profits, improve productivity and guarantee satisfied customers. Your first job using Boyd products will pay for this video.



PART #	DESCRIPTION
BOY-VID	On Press Magic Video

Litho-Punch

Litho-Punch creates a punched circular cut that remains lightly attached for removal by the end user. Ideal for making circular punches in promotional pieces for binder inserts. Available in diameters of 1/8", 3/16", 1/4", 3/8", 1/2", 1", 1 1/4" or 1 1/2", with other sizes available by special order. A serrated or straight-cut edge may be used. Available for both paper and card stocks.

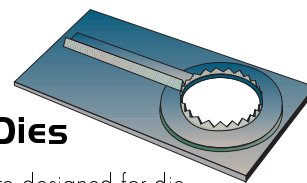
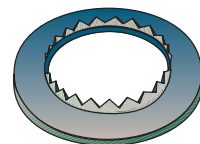

Litho-Dies

Litho-Dies are designed for die cutting on the offset press. Doorknob and window dies are available in a variety of sizes. In addition, dies in a variety of complex shapes can be custom made to your specifications. All are mounted on shimstock for ease of attachment, and are heat-treated.

NOTE: Contact Customer Service for ordering information on Litho-Punch and Litho-Dies.



Clear mounting tape for H.S. Boyd rules is available. Order part BOY-208.

JOMAC BRAND DAMPENING COVERS



Cotton Products

The Jomac brand has become synonymous with premier, seamless, cotton dampening covers.

- **A-TEX**® – This is the original seamless, cotton dampening cover for form and ductor rollers. It is a bleached, absorbent, cotton-looped fabric.
- **Uni-Damp**® – A uniformly sheared cover that has a velvety-smooth surface, resembling velour.
- **Seamol**® – Specifically designed to withstand the high speeds of large web presses, Seamol is strong, durable and will not mat or pack down.
- **J-Knit**® – A versatile cover that is ideal for fast color changes on sheet-fed or web presses.
- **J-Lastic**® – An elasticized cotton cover that is highly absorbent and an excellent alternative to linen covers for the water pan or intermediate ductor roller.

Jomac Brand Slip-On Tubes

Specifically designed to facilitate the installation of new, seamless dampening covers. Made of phenolic resin to provide a rigid, smooth surface.



Visit our web site for a schematic of the Heidelberg Dampening Rollers. This will help you choose the correct Jomac brand covers for your press.

JOMAC® BRAND DAMPENING COVERS

Jomac has been a leader in the production of seamless dampening covers since they introduced circular-knit A-TEX material in 1938. Over the years, the line has improved and expanded to the point where it is the largest, high quality line of dampening products available. For almost 20 years, the Jomac brand has lead the industry in the production of very high quality, seamless, synthetic roller covers.

Synthetic Covers

These covers feature a lint-free surface on a shrink-to-fit base to produce sharper dots and better dampening control.

- **Greensleeves**® – A premium quality, shrink-to-fit, lint-free cover for form and ductor rollers on web and sheetfed presses.
- **The Shrink Cover**® – An economical, heavy-duty, shrink-to-fit, lint-free cover for the form and ductor rollers on smaller sheetfed presses.
- **Super Damp**® – This combination synthetic/cotton cover provides the convenience of shrink-to-fit with the water control of cotton.
- **Dura-Shrink**® – A shrink-to-fit dampening cover designed for the intermediate ductor roller on Heidelberg K-Series presses. Available in pre-cut sleeves, supplied with a draw-string on one end, the opposite end is secured with a cable tie, then trimmed to fit the specific roller. Sold in packages of three with cable ties and mounting tube.
- **Watersleeves**® – A shrink-to-fit cover designed for the form roller on sheetfed and web presses to replace paper sleeves. Custom made with draw-strings to fit all presses. Sold in packages of three with mounting tube.
- **J-Lastic Synthetic**® – An elasticized alternative to paper dampeners and a premium quality cover for the water pan and intermediate ductor roller.



Please refer to pages 104 and 105 for Jomac Brand gloves, drain covers and drain plugs.

Newspaper Products

The Jomac brand dedication to the newspaper industry precedes seamless covers. The Jomac goal has been to improve quality while holding costs in check.

- **GSS News-Knit**® – Developed for the water pick-up rollers of large web newspaper presses, this shrink cover provides consistent absorbency and a long, lint-free life.
- **News-Knit**® – This is a medium weight cotton cover designed for the water pick-up roller on web newspaper presses.
- **Bild-Up**® – This is a lightweight cotton cover for the water pick-up rollers on web newspaper presses.

NOTE: All Jomac Brand dampening materials are available in rolls and cut covers from Lithco. Contact your dealer or Lithco Customer Service for size specifications and part numbers for individual presses.

Jomac Brand Dampening Chemicals

➤ Dampening Prep Solution

Use to enhance the water affinity of the dampening rollers and covers of the press water system. Applies an even, thin and smooth water film to the plate. Prevents ink contamination and is suitable for continuous dampeners.

➤ Dampening Cover Cleaner

Specifically formulated to remove ink from dampening covers, rubber and synthetic rollers and rubber gloves. This gentle but strong concentrated detergent is also suitable for general pressroom cleaning. Rinses clean without any residue.

PART #	SIZE	DESCRIPTION
JOM-DPS	Quart	Dampener Prep Solution
JOM-DCC	Gallon	Dampening Cover Cleaner

Base-Line & REL® Pens

A wide variety of pens to meet your requirements for any plate

Base-Line supplies a full line of REL® and Base-Line brand graphic arts pens in a wide assortment of point styles. Specially formulated to add or delete images on plate materials.

PART #	TIP	DESCRIPTION
REL-1001	Fine	Metal Plate Deletion Pen
REL-1002	Broad	Metal Plate Deletion Pen
REL-2001	Fine	Metal Plate Addition Pen
REL-2002	Broad	Metal Plate Addition Pen
REL-2006	Twin Point	Metal Plate Addition Pen (Two-step)
REL-5001	Fine	Silvermaster Deletion Pen
REL-5002	Broad	Silvermaster Deletion Pen
REL-5003	Brush	Silvermaster Deletion Pen
REL-5015	Twin Point	Silvermaster Deletion Pen (X-Fine and Medium Points)
REL-5000	Fine	Silvermaster Addition Pen
REL-5020	Broad	Silvermaster Addition Pen
REL-5000K	Kit	Silvermaster Kit (#5003 and #5000)
REL-7001	Fine Brush	Electrostatic Deletion Pen
REL-7003	Fine	Electrostatic Deletion Pen
REL-7004	Broad	Electrostatic Deletion Pen
REL-7005	Broad Brush	Electrostatic Deletion Pen
REL-7002	Fine	Electrostatic Addition Pen



Base-Line Cleanup Sheets

The environmentally safer way to clean the press

Ink belongs on paper, not people, and not as hazardous waste in clean-up attachments. Base-Line is the premier manufacturer of cleanup sheets.

- Accurately trimmed and finished in pinbar, slotted or straight edge configurations
- Manufactured from heavy-duty stock for superior wet strength and absorbency
- Usable on both sides and virtually lint-free



Three-Tipped Plate Correction Pens

Unique design allows for maximum flexibility in pen usage.

- Metal plate CTP Deletion Pen has a unique 3-tip barrel with fine, medium and broad points to give you improved control over the deletion fluid
- Metal plate Long Run Addition Pen lasts for hundreds of thousands of impressions, featuring a one-of-a-kind prep tip that prepares the plate surface for the addition fluid
- Combination addition/deletion electrostatic plate pen (not shown)



PART #	DESCRIPTION
BAS-CTP	CTP Deletion Pen
BAS-CTPA	Long Run Addition Pen
BAS-EL7000	E-stat Combo Pen



Visit web link #P751 for a chart listing plates compatible with

the specially formulated Base-Line metal plate CTP Addition and Deletion Pens. Their unique design and formulation makes them a must for today's long-run plates.

The Base-Line Worry-Free Warranty

Base-Line backs every product we sell with an absolute guarantee for quality, value, reliability and excellent customer service. If you are not satisfied with the performance of any Base-Line product, we will replace it or refund your money.

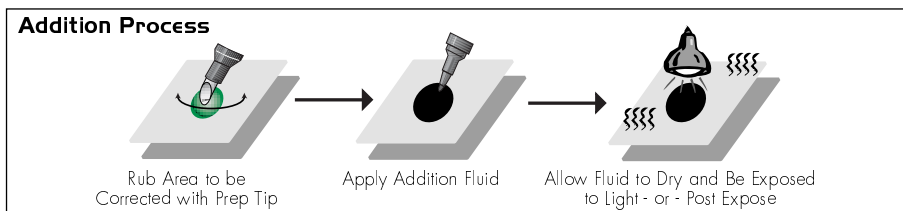
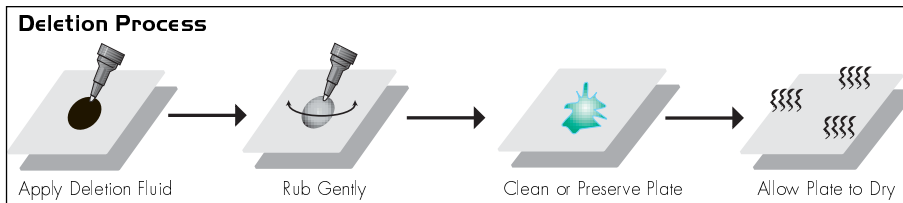

Other fine Base-Line Graphic Arts Products are located on pages 53, 56 and 57.

DAMPENING COVERS



Red Runner™ Dampening Sleeves

Red Runner™ Dampening Sleeves will not break, crack, split, or shred. Designed for long-lasting, pattern-free performance. The slip-on, shrink-fit technology ensures optimal water control.



Hyton® Dampening Covers

Manufactured using specially processed continuous filament rayon yarns, Hyton Dampening Covers insure lint-free, ink-resistant performance. Designed for maximum durability.

Red-I® Dampening Covers

Composed of tightly-knit continuous filament synthetic yarns, Red-I's SHRINK dampening material prevents creeping and twisting. These ink-resistant, lint-free covers are perfect for all conventional offset dampening systems. Designed for easy clean-up.

NOTE: All BBA Nonwovens Dampening Sleeves are available in rolls and cut covers from Lithco. Contact your dealer or Lithco Customer Service for additional product details and for size specifications and part numbers for individual presses.

Lithco Dampening Covers

Lithco offers Seamless "Molleton" covers and seamless Velour covers for all popular duplicator size presses. Available in either sets, individual forms, or individual ductors. Covers have drawstrings on both ends. Large press covers are available on special order. The roller face length, bare roller diameter and any undercover material being used should be specified.



Lithco Linen Covering

This durable, lint-free, long-running water pan roller covering is ideal for use on older presses with a steel water pan roller. Provides additional wetting capacity on newer presses with chrome rollers. Available in rolls or by the yard.



Lithco Paper Damp

An economical, paper form roller covering. Spiral wraps around roller and secures on roller journals with elastic bands or pipe clamps. Lint-free and long life make this a favorite with many pressmen. Gauge is .003". Approximately 2 lb. rolls.



PART #	DESCRIPTION
MIS-PD	Paper Damp

Lithco Sewing Thread and Straight Needle

Perfect for sewing the ends of seamless dampening covers. Waxed for added resistance to fountain chemistry. Straight needle sold separately.



PART #	DESCRIPTION
MIS-WTHREAD	Thread - 1 lb. Spool
MIS-SN	Straight Needle for Sewing Covers

Lithco EZ Knife

The safest way to remove old dampening covers without cutting the roller or yourself. Curved blade cuts up into the cover as you push the knife away from yourself.

PART #	DESCRIPTION
LIT-EZ	Knife with 1 Blade
LIT-EZB	Package of 2 Replacement Blades





Plastic Ink Knives - Four Color Sets

Color-coded for easy identification

Set of four plastic ink knives, one each in red, blue, yellow and black. Designed to fit into one pound ink cans.

PART #	DESCRIP.	BLADE WIDTH	BLADE LENGTH
MIS-IKNPSS	Set of Four Small Plastic Ink Knives	1 3/4"	5 1/2"
MIS-IKNPMS	Set of Four Medium Plastic Ink Knives	2 3/4"	5 1/4"

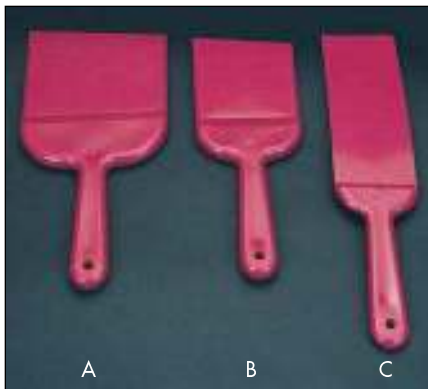

Plastic Ink Knives

Will not scratch nylon or Teflon™ ink feed systems

A great, new concept in ink knives. Made of chemically-resistant plastic. The medium and large sizes are excellent for removing excess ink from fountains.

PART #	DESCRIP.	BLADE WIDTH	BLADE LENGTH
MIS-IKNPL	Large (A)	5 3/8"	4"
MIS-IKNPM	Medium (B)	4"	4"
MIS-IKNPR	Regular (C)	3"	8"

Russell Ink Knives

Available in flexible and stiff blade styles

- Manufactured from the best grade of tool steel
- Mirror-finish blade
- Rosewood handles with full-length tang, brass rivets and grommet

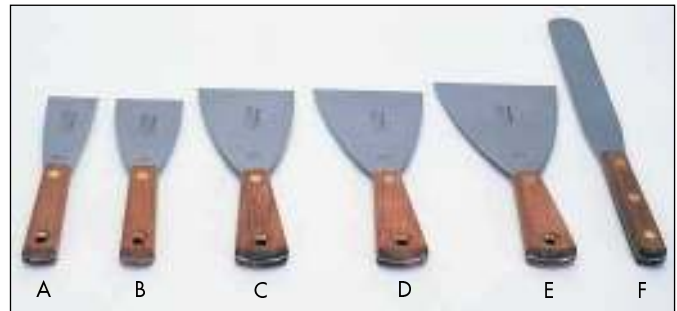

PART #	SHAPE	PHOTO	STYLE	BLADE WIDTH	BLADE LENGTH
MIS-IKNF1 1/2	Knife		Flexible	1 1/2"	3 1/2"
MIS-IKNS1 1/2	Knife	(A)	Stiff	1 1/2"	3 1/2"
MIS-IKNF2	Knife	(B)	Flexible	2"	3 1/2"
MIS-IKNS2	Knife		Stiff	2"	3 1/2"
MIS-ISCF3	Scraper	(C)	Flexible	3"	4 1/4"
MIS-ISCS3	Scraper		Stiff	3"	4 1/4"
MIS-ISCS3 1/2	Scraper	(D)	Stiff	3 1/2"	4 1/4"
MIS-ISCF4	Scraper	(E)	Flexible	4"	4 1/4"
MIS-ISCS4	Scraper		Stiff	4"	4 1/4"
MIS-ISCF5	Scraper		Flexible	5"	4 1/4"
MIS-ISPF6	Spatula	(F)	Flexible	7/8"	6"
MIS-ISPF8	Spatula		Flexible	7/8"	8"
MIS-ISPF10	Spatula		Flexible	1 5/8"	10"

Lamson Ink Knives



Full length carbon steel blades are hardened and tempered for durability

- Knives have brass rivets and grommets
- Hand-crafted rosewood handles
- Full length tang

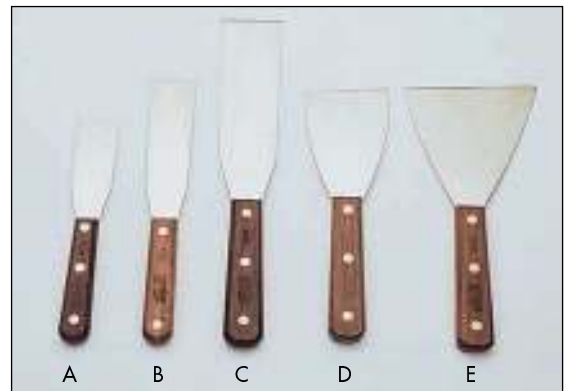

PART #	SHAPE	PHOTO	STYLE	BLADE WIDTH	BLADE LENGTH
MIS-IKN9004	Knife	(A)	S/Flexible	1 1/2"	4"
MIS-IKN9006	Knife	(B)	S/Flexible	1 3/4"	6"
MIS-IKN9008	Knife	(C)	S/Flexible	2 1/2"	8"
MIS-IKN90010	Knife		S/Flexible	2 7/8"	10"
MIS-IKN90012	Knife		S/Flexible	3 1/8"	12"
MIS-ISC9806E3	Scraper	(D)	Flexible	3"	4 1/2"
MIS-ISC9806E4	Scraper		Flexible	4"	4 3/4"
MIS-ISC9806E5	Scraper	(E)	Flexible	5"	5 1/2"
MIS-ISC98063	Scraper		Stiff	3"	4 1/2"
MIS-ISC98064	Scraper		Stiff	4"	4 3/4"
MIS-ISC98065	Scraper		Stiff	5"	5 1/2"



Russell & Lamson ink knives not listed are also available.

VAN SON INK

CML-Oil Base Plus®

Specially formulated for duplicators

- For coated and uncoated stocks
- For all plates, especially Silvermaster™
- Rub-resistant, high gloss surface
- Conventional or integrated dampening
- Nightly clean-up recommended



Rubber Base Plus®

For uncoated papers

- For all metal and electrostatic plates
- Conventional or integrated dampening
- Will not skin in the can or on the press
- Ideal for thermography, forms and envelope printers
- Immediate setting

INFINITY® Acrylic

The ultimate acrylic!

- Dries hard and fast on coated and uncoated stocks
- Performs flawlessly with all plate systems
- Unique acrylic varnish concept virtually eliminates toning
- Stays open on the press overnight
- No waste due to skinning in the can

SonaPrint®

Ideal for small to mid-sized commercial presses

- Unique varnish concept allows for less water pick up, more mileage and greater color density
- Dries to a high gloss, rub resistant surface on coated stock
- Stays open all day on press rollers and in the fountain, yet dries exceptionally fast on paper
- Vacuum sealed, free of contaminants and impurities
- Available in any PANTONE® Color, a balanced set of process colors and an all purpose Intense Black

CML-OIL BASE PLUS		RUBBER BASE		INFINITY ACRYLIC		SONAPRINT	DESCRIPTION - COLOR
1 lb.	5 lbs.	1 lb.	5 lbs.	1 lb.	5 lbs.	1 kilo (2.2 lbs.)	
VS745	VS795	VS101	VS151	VS103	VS153	VS856	All Purpose Black
VS700	VS750	VS300	VS500	41600	-	VS840	PANTONE® Violet
VS701	VS751	VS301	VS501	41601	41701	VS841	PANTONE Yellow
VS702	VS752	VS302	VS502	41602	41702	VS842	PANTONE Warm Red
VS703	VS753	VS303	VS503	41603	41703	VS843	PANTONE Rubine Red
VS704	VS754	VS304	VS504	41604	-	VS844	PANTONE Rho. Red
VS705	VS755	VS305	VS505	41605	-	VS845	PANTONE Purple
VS706	VS756	VS306	VS506	41606	41706	VS846	PANTONE Reflex Blue
VS707	VS757	VS307	VS507	41607	41707	VS847	PANTONE Process Blue
VS708	VS758	VS308	VS508	41608	41708	VS848	PANTONE Green
VS709	VS759	VS309	VS509	41609	41709	VS849	PANTONE Transparent White
VS710	VS760	VS310	VS510	41610	41710	VS850	PANTONE Black
VS730	-	-	-	41620	-	VS829	PANTONE Yellow 012
VS737	-	VS320	-	41621	-	VS830	PANTONE Orange 021
VS863	VS868	VS312	VS512	41612	-	VS831	PANTONE Red 032
VS864	-	VS325	-	41622	-	VS832	PANTONE Blue 072
VS715	VS765	VS329	VS529	41613	41713	VS833	PANTONE 185/Dutch Fireball
VS716	VS766	VS346	VS546	41614	41714	VS834	PANTONE 199/Red Pepper
VS719	VS769	VS339	VS539	41618	-	VS835	PANTONE 293/Liberty Blue
VS720	VS770	VS316	VS516	41615	-	VS836	PANTONE 300/Brilliant Blue
-	-	-	-	41623	-	-	Teal
VS721	VS771	VS338	VS538	41616	41716	VS837	PANTONE 347/Ivy Mint
VS725	-	VS350	-	41617	-	VS838	PANTONE 469/Autm. Brown
VS731	VS781	VS314	VS514	41619	41719	VS839	Bordeaux Red
VS746	VS796	-	-	-	-	VS851	Process Yellow
VS747	VS797	-	-	-	-	VS852	Process Magenta
VS748	VS798	-	-	-	-	VS853	Process Cyan
VS749	VS799	-	-	-	-	VS854	Process Black

NOTE: Add VAN- before each number above to form a complete Lithco part number.

Tough Tex®

For non-porous or varnished surfaces

- Dries by oxidation
- Exceptional fade resistance and rub resistance
- "Laser safe"



Van Son Digital Inks can be found on pages 40 and 41.

Tough Tex LR®

Light resistant

- The most fade resistant colors available
- Pigments are both chemical and weather resistant
- Forms a highly heat resistant surface that is "Laser safe" after curing 48-72 hours
- Environmentally friendly — high vegetable oil content, low VOCs
- Can be used for any wax free application

Sonagloss

Ideal for mid-to-large size sheet-fed presses



- Instant setting
- Excellent roller stability
- Unequalled trapping
- Extraordinary rub resistance
- For coated and uncoated stocks
- Vacuum-sealed freshness

VAN SON SPECIALTY INKS



Van Son Unipak Gold & Silver

Pre-mixed metallic for litho and letterpress printing

- Ready to run right out of the can
- High brilliance and good printability
- Excellent rub resistance
- Extremely opaque
- Packaged in 1 kilo (2.2 lb.) cans

UNIPAK METALLIC INKS	
PART #	DESCRIPTION
VS283	Unipak Light Gold
VS280	Unipak Middle Gold
VS281	Unipak Deep Gold
VS282	Unipak Silver
VS871	Unipak PANTONE® 871 Gold
VS872	Unipak PANTONE 872 Gold
VS873	Unipak PANTONE 873 Gold
VS874	Unipak PANTONE 874 Gold
VS875	Unipak PANTONE 875 Gold
VS876	Unipak PANTONE 876 Gold
VS877	Unipak PANTONE 877 Silver

NOTE: Add VAN- before each number to form a complete Lithco part number.

		PART #			DESCRIPTION - COLOR
		TOUGH TEX LR ¹	SONAGLOSS ²		
TOUGH TEX ¹		TOUGH TEX LR ¹	SONAGLOSS ²		
1 lb.	1 kilo (2.2 lb.)	1 kilo (2.2 lb.)	1 kilo (2.2 lb.)	2.5 kilo (5.5 lb.)	
VS394	VS494	—	VS276	VS376	All Purpose Black 10577
VS359	—	33100*	VS260	—	PANTONE Violet
VS381	44100	33101*	—	VS361	PANTONE Yellow
VS382	44101	33102*	—	VS362	PANTONE Warm Red
VS383	44102	33103*	—	VS363	PANTONE Rubine Red
VS384	—	33104*	—	VS364	PANTONE Rhodamine Red
VS385	—	33105*	—	VS365	PANTONE Purple
VS386	44105	33106*	—	VS366	PANTONE Reflex Blue
VS387	44106	33107*	—	VS367	PANTONE Process Blue
VS388	—	33108*	—	VS368	PANTONE Green
VS389	—	33109*	—	VS369	PANTONE Transparent White
VS390	—	33110*	—	VS370	PANTONE Black
VS378	—	—	—	—	PANTONE 185 Dutch Fireball
VS392	—	—	—	—	Metallic Gold
VS391	—	—	—	—	Metallic Silver
VS395	—	—	—	—	Opaque White
			VS271	VS371	Process Yellow
			VS272	VS372	Process Magenta
			VS273	VS373	Process Cyan
			VS274	VS374	Process Black

¹Tough Tex is available in any PANTONE Color.

²Sonagloss is also available in Intense Black, Royal Black and any PANTONE Color.

*Approximate PANTONE Match



Turn this page to find Van Son Pressroom Supplies.

Van Son Heat Transfer Inks

Heat Transfer Inks are formulated to transfer an offset printed image from paper to a synthetic fabric. This process involves a physical change of the colored dye from the solid state on paper to a vapor and then back to a solid state, which becomes anchored to the fabric. Packaged in 1 lb. cans.

PART #	DESCRIPTION
V880	Heat Transfer Process Yellow
V881	Heat Transfer Process Red
V882	Heat Transfer Process Blue
V883	Heat Transfer Process Black

Fluorescents

For high impact visibility!

Packaged in 1 lb. cans.

PART #	DESCRIPTION
801	Blue
802	Green
803	Yellow
804	Orange
805	Red
806	Pink
807	Magenta



PANTONE® Color Mixed Inks

All mixes are priced per pound, per color and include Next Day Air Service (excluding Sonaprint). Any Van Son Ink formulation is available. Place an order for a PANTONE Color Mix prior to 3 PM local time and it will be delivered the next day, via prepaid air. Orders received after 3 PM will be shipped the following day. For orders containing an excess of 20 pounds of an individual color, 20 pounds of each color will be shipped by air for next day delivery and the balance by UPS Ground. (Quantity pricing is available.)

VAN SON PRESSROOM SUPPLIES



Easy Street

Nothing cleans rollers like Easy Street!

A one step deglazer and roller conditioner pulls ink and glaze out like never before. Non-toxic, odorless and non-flammable.

Tack Reducer

Reduces the tack of the ink without affecting viscosity!

It has a buttery consistency rather than liquid, and can be used with any duplicator ink.

Smooth Lith

Reduces tack and viscosity to prevent picking without affecting ink color

A smooth-lay, anti-off-set compound in liquid form mixes easily with ink.

Aqua Flo Varnish #30

This heavy bodied litho varnish is used to build up the body of the ink

Can increase tack of ink, as well. Excellent for inks that are to be used with integrated dampening systems to build up maximum water repellence.

All Purpose Fountain Solution

Works with all presses and dampening systems

Helps to eliminate ink emulsification, plate breakdown, roller stripping as well as glazing and copy fading.

PART #	DESCRIPTION	SIZE
Ink Additives		
V2159	Aqua Flo Varnish #30	1 lb.
V2163	Liquid Cobalt Drier	1 lb.
V2154	Meg-a-Magic Drier	8 oz. Tube
V2177	Multi-Drier	8 oz. Tube
V2150	Smooth Lith	Quart
VS377	Sonatack (Sonagloss Additive)	Kilo
V2155	Three Way Drier	1 lb.
V2162	Tack Reducer	1 lb.
Overprint Varnishes		
V2174	High Gloss Overprint Varnish	1 lb.
V2175	High Gloss Overprint Varnish	4.5 lb.
V2156	High Gloss Overprint Varnish	25 lb.
V2171	Matte Overprint Varnish	4.5 lb.
V2176	Ultra Gloss Overprint Varnish	4.5 lb.
Fountain Solutions & Additives		
V2020	All Purpose Fountain Solution	Gallon
V2153	Fountain Stimulator	½ Gal.
Roller Deglazers & Cleaners		
V2028	Rapid One Step Glaze Remover*	Quart
V2029	Rapid One Step Glaze Remover*	Gallon
V2018	Rapid One Step Glaze Remover*	5 Gal. Pail
V2082	Easy Street	10 oz. Tube
V2083	Easy Street	9 lb. Pail
Press Room Supplies		
V2003	Blue Denim Printer's Apron	—
V2004	Blanket Fix	4 oz.
V2007	Cleaning Cloths (10 pound box)	Case
V2105	Ink Cans (one pound – plain)	Box/6
V2123	Ink Cans (five pound – plain)	Box/4
V2876	Ink Knife Set, plastic 4-color	Set/4
V2035	Oil Soaker Bags	Box/12
V2085	Quick	10 oz. Tube
V2101	PANTONE formula guide	—

NOTE: Add VAN- before each number above to form a complete Lithco part number.

*Not available for distribution in California.

Fountain Stimulator

A water-soluble drier that is added to the fountain solution (not the ink) avoiding contamination of the ink. The ink receives an added drying boost when it meets the water on the plate at the instant of printing.

Blanket Fix

It's easy to fix low spots on blankets with just a small amount. Apply to the low spot, wait up to 90 seconds; wipe the spot with blanket wash. The blanket will continue to perform like new!

New PANTONE formula guide

With 1147 solid PANTONE Colors, the PANTONE formula guide is the heart of the PANTONE MATCHING SYSTEM, and the most utilized color guide in the world.



PANTONE® Color Ink Balance

This reliable ink mixing scale quickly pays for itself in a busy print shop

Programmed to provide exact ink formulas for over 1000 PANTONE MATCHING SYSTEM® Colors. Save time, money and eliminate waste by mixing only what you need, when you need it. Optional program cards for PANTONE Pastel and PANTONE Metallic Colors extend achievable mixing range. Weighing capacity 2.425 lb. (1100 gm).

- Reformulate pre-mixed inks into new colors for extra flexibility and savings
- Built-in recalculation function lets you turn a mixing error into profit
- Easy-to-use operation permits the use of PANTONE Numbers or conventional weighing



PANTONE Formula Scale 2

Thanks to the unique combination of digital electronic weighing scales and computerized electronics, mixing accurate PANTONE Colors has never been easier or quicker. Just key in the PANTONE Number and quantity of ink required, then follow the steps through the weighing sequence. It is as simple as that!

- All PANTONE Formulae are already programmed into memory
- Precise weights of the basic color inks needed for the mix are calculated automatically
- New feature allows you to save the mix if you accidentally add too much of one component
- Ensure accurate ink formulations time-after-time
- Available in 10 lb. and 50 lb. capacities

PART #	CAPACITY	DESCRIPTION
EQP-PANCB	2.4 lb.	Color Ink Balance
EQP-PANFS2	10 lb.	Formula Scale 2
EQP-PANFS2HD	50 lb.	Formula Scale 2

Triple Beam Balances

These classic mechanical balances are engineered with Ohaus precision and durability.



PART #	DESCRIPTION	CAPACITY	MAXIMUM CAPACITY*	WEIGHING INCREMENT
EQP-OH750S0	Triple Beam Balance	610 gm (1.35 lb.)	2610 gm (5.8 lbs)	0.1 gm
EQP-OH76000	Triple Beam Balance, with Tare	610 gm (1.35 lb.)	2610 gm (5.8 lbs.)	0.1 gm
EQP-OH165000	Dial-O-Gram Balance	610 gm (1.35 lb.)	2610 gm (5.8 lbs.)	0.1 gm
EQP-OH70700	Metric Weight Set	2-1000 gm, 1-500 gm	n/a	n/a
EQP-OH86000	Triple Beam Balance, with Tare	1 lb. 2 oz.	5 lb. 2 oz.	0.01 oz.
EQP-OH80703	English Weight Set	2-2 lb., 1-1 lb.	n/a	n/a

*With optional attachment mass sets

Electronic Balances

The Scout™ II is a portable, affordable, precision electronic balance. It features a large LCD display, RS232 interface option, a large stainless steel weighing surface and automatic shut-off. The Navigator™ is a full featured scale with both English and metric weighing, RS232 bi-directional interface, automatic shutoff, percent functions, parts counting and much more. AC adapter included. Units can also be battery powered (Batteries not included).



PART #	MODEL	CAPACITY	WEIGHING INCREMENT
EQP-OHSC4010	Scout II	400 gm (0.88 lb.)	0.1 gm (.0035 oz.)
EQP-OHSC6010	Scout II	600 gm (1.32 lb.)	0.1 gm (.0035 oz.)
EQP-OHNOB110	Navigator	2100 gm (4.6 lb.)	0.1 gm (.0035 oz.)
EQP-OHNOH110	Navigator	8100 gm (17.8 lb.)	0.5 gm (.0175 oz.)

OAKTON METERS

OAKTON METERS



Pressroom quality control at affordable prices!

Accurate mixing and monitoring of press fountain solutions are integral parts of quality printing. Changes in technology and raw materials present a constant challenge to today's press operators. Oakton's advanced microprocessor design in portable, pocket-sized meters makes them a leader in quality control instruments for the lithographic industry.

pH Quality Control — Oakton pH Testers™ are microprocessor-based for exceptionally fast, stable, accurate and repeatable pH readings. Eliminate the guesswork associated with common paper pH test strips. All Oakton pH Meters are Waterproof...and THEY FLOAT!

Waterproof pH Testr™ Deluxe Kit

The Waterproof pH Testr is fully waterproof and dustproof for added margin of safety. This kit contains everything you need including a meter, calibration solution pouches, sampling vial, instructions and storage case.

- Replaceable electrode
- Push-button calibration automatically adjusts readings to the buffer
- Hold button allows the unit to maintain the reading until it can be logged
- Auto-off turns unit off after 8.5 minutes of nonuse to conserve batteries
- Self-diagnostic error messages warn of low batteries, over/under range conditions or incorrect calibration point



See web link #P821 for tips on using Oakton Meters to troubleshoot fountain solution problems.



TempTestr IR

Infrared measurement provides safe, non-contact temperature readings

Take measurements from a safe working distance, or under conditions when you cannot physically get close enough to take readings. Use the TempTestr IR to monitor ink roller temperatures, gas drying unit temperatures, thermography tunnels, high-speed web presses or electrical components in the pressroom and bindery. The possibilities are endless. Sold complete with batteries and instructions.

- Extremely fast results — only 500 msec for 95% response
- Simple one button operation — just point and press
- Wide operation range — 0° to 500° F with accuracy of ±2% between 77° and 500° F
- Selectable °F/°C display
- Hold function freezes display for seven seconds after button release
- Model with laser sighting available, enabling you to pinpoint your exact target area with a red laser spot
- Economical

Waterproof Double Junction pH Testr



The pH tester for harsh applications

The double junction electrode design and increased reference gel volume allow for significantly longer electrode life, especially in harsh applications like plate chemistry, activator and stabilizer. Same features as the Waterproof pH Testr above. (Not pictured.)

PART #	DESCRIPTION	RANGE
MIS-PHKW	pH Meter Deluxe Kit, Waterproof	-1 to 15 pH
MIS-PHRE	Replacement Electrode for Waterproof Tester	
MIS-PHKWDJ	Double Junction pH Meter, Waterproof	-1 to 15 pH
MIS-PHREDJ	Replacement Electrode for Double Junction Waterproof Tester	

Fountain Solution Continuous Monitoring Kit



Microprocessor-based real-time monitoring of fountain solution in continuous dampening units

Now you can instantly know your fountain solution temperature, pH and conductivity at a glance. Two probes connect to the monitors for constant digital readout.

- Two SPDT set point relays per monitor (pH and Conductivity) can be used to activate replenishment pumps, valves or alarms
- All push-button operation with large LED displays
- Three-point pH calibration; one point conductivity calibration
- Automatic temperature compensation (ATC)
- Available with either in-line probes or submersible probes
- 1-year warranty



PART #	PROBES	DESCRIPTION
MIS-CMKIL	In-Line	Continuous Monitoring Kit
MIS-CMKS	Submersible	Continuous Monitoring Kit

PART #	DESCRIPTION
MIS-TEMPIR	Temp Testr IR
MIS-TEMPIRL	Temp Testr IR with Laser Sighting

Continuous monitoring kits include pH and Conductivity monitors, choice of in-line or submersible probes and NEMA case with mounting hardware. User installation required. Other configurations, including hard copy recording and remote monitoring are available. Please inquire.

Temp Testr™

Utilize this handy meter to monitor fountain solution chemistry for maximum wetting conditions and eliminate errors in film and plate processing.

- °F or °C selectable scale, defaulting to °F when turned on
- Hold function permits retaining a reading in hard-to-reach or poorly lit conditions
- Microprocessor-based for speed and accuracy
- Self-diagnostic error messages warn of low batteries or out-of-range operating conditions
- Plug-in temperature probe eliminates stripped or crossed threads
- Complete with batteries, non-replaceable stainless probe and instructions



PART #	DESCRIPTION
MIS-TEMP	Temp Testr

Conductivity Measurement

Maximum quality control necessitates frequent conductivity readings of the fountain solution. Contamination from paper coatings, ink and spray powder often cannot be determined with pH readings. Only conductivity monitoring pin-points problems before they occur.

Waterproof Conductivity Testr™ Microprocessor-based Deluxe Kit



These testers offer ±1% full-scale accuracy

The Waterproof Conductivity Testr is fully waterproof and dustproof for a margin of safety. It has the added speed and convenience of a microprocessor.

- Replaceable electrode
- Automatic Temperature Compensation (ATC)
- Features 1-point push button calibration, hold button, self-diagnostic error messages, and auto-shutoff after 8.5 minutes
- Full-scale LCD read-out for faster, easier reading
- Available in two models for different types of water



Conductivity Testr™ Dual Range Deluxe Kit

Use one tester when taking readings over a wide range of water purities.

Note: This unit is not waterproof. (Not pictured.)

- Automatic Temperature Compensation (ATC)
- Accuracy of ± 2%
- Features 2-point push button calibration, hold button, self-diagnostic error messages, and auto-shutoff after 8.5 minutes

All conductivity kits contain everything you need including a meter, calibration solution pouches, sampling vial, instructions and storage case.

PART#	DESCRIPTION	RANGE	APPLICATION
MIS-CONKW	Deluxe Kit, Standard Range	0 to 1999 µmho	Purified, Water
MIS-CONKWH	Deluxe Kit, High Range	0 to 19,900 µmho	Tap Water
MIS-CONWRE	Replacement Electrode	High or Low	Purified or Tap Water
MIS-CONKD	Deluxe Kit, Dual Range	0 to 1999 µmho & 0 to 19,900 µmho	Purified or Tap Water

**Micromho is the measurement of conductivity. 1 mmho = 1 mSiemen (mS).*

Calibration Pouches - Accessories



BeltHoop style carrying cases are the best way to keep your Oakton Meters at your side. Don't forget to keep replacement batteries handy, just in case. Single-use calibration pouches feature 20 ml of fresh, pre-mixed solution. Sold 20 per box.

PART #	DESCRIPTION
MIS-WPCC	Waterproof Testr Carrying Case, Single
MIS-TEMPIC	Temp Testr IR Carrying Case
MIS-TESTBAT	Batteries, 6 Batteries Per Package
MIS-PHCP4	4.01 pH Calibration Pouches
MIS-PHCP7	7.00 pH Calibration Pouches
MIS-PHCP10	10.00 pH Calibration Pouches
MIS-PHCPR	Rinse Water Pouches
MIS-PHCPA	pH Sampler Assortment - 4.01, 7.00, 10.00
MIS-CONCP1413	1413 µmhos Calibration Pouches
MIS-CONCP15000	15,000 µmhos Calibration Pouches

MYRON L METERS

Myron L Meters



Accuracy, reliability and simplicity

Founded in 1957, Myron L Company has become one of the world's leading manufacturers of water quality test instruments. All listed Myron L pH meters feature a replaceable pH sensor.

**MYRON L
COMPANY**

Conductivity Meter Combination pH/Conductivity Meter

Among the most reliable and popular instruments of their kind in the world

The Myron L Company has developed two basic units to measure water purity, a 512M5 conductivity meter to measure dissolved solids and a M6 combination pH/conductivity meter to measure dissolved solids and pH.

- *Lightweight and compact*
- *Rugged, taut-band meter movements for durability and years of reliability*
- *512M5 range 0 to 5000 mS*
- *M6 range 0 to 5000 mS; 2 to 12 pH*
- *Optional Litho Kit available (contains calibration solutions, syringe for drawing sample solution, thermometer and carry case)*



M6



512M5



M6 w/OPTIONAL LITHO KIT

Myron L TechPro™ ARH1 Meter

Combination meter for pH, conductivity and temperature

Designed with internal electrodes to prevent breakage and prolong the electrode's useful life, the rugged yet lightweight, water-resistant case protects the internal components of the instrument. Features an automatic shut-off to prolong battery life.

- *Three conductivity ranges – from 0 to 19,999 mmhos*
- *pH range of 0 to 14*
- *Temperature range of 32° F to 160° F*
- *Optional foam-lined carrying case available with solutions*



TECHPRO ARH1



TECHPRO ARH1 w/OPTIONAL CASE AND SOLUTIONS

Myron L Ultrameter™ 6P

This fully waterproof unit does the job of six instruments...and it floats

The Ultrameter™ is a prime example of how high-tech engineering can greatly simplify and streamline a task. Regardless of the function, simply fill the cup, push a parameter button and take the reading. The Ultrameter will measure all of the following:

- *Conductivity from 0 to 200,000 mmhos in five autoranges*
- *Resistivity from 10KΩ to 30MΩ*
- *Total Dissolved Solids from 0 to 200 ppt in five autoranges*
- *pH from 0 to 14*
- *Oxidation-Reduction Potential (ORP) ±999 mV*
- *Temperature from 32° F to 160° F*
- *Optional hard, protective case with calibrating solutions available (kit)*



ULTRAMETER 6P



ULTRAMETER 6P w/OPTIONAL CASE AND SOLUTIONS

Myron L Accessories

Carrying cases, replacement pH sensors and calibrating solutions

PART #	DESCRIPTION
EQP-MLM6LK	M6 Litho Kit
EQP-ML512M5LK	512M5 Litho Kit
EQP-MLARH1K	TechPro ARH1 Foam-lined Case w/Solutions
EQP-MLUM6PK	Ultrameter 6P Foam-lined Case w/Solutions
EQP-MLUCC	Soft Case w/Belt Clip – Ultrameter & TechPro
EQP-MLM6RS	Replacement pH Sensor – M6 only
EQP-MLARH1RS	Replacement pH Sensor – TechPro only
EQP-MLUM6PRS	Replacement pH Sensor – Ultrameter only
EQP-MLC	Carrying Case for 512M5 or M6
EQP-MLCONCS	NIST Traceable Conductivity Standard Solution
EQP-MLPHx*	NIST Traceable pH Solution – 4.0, 7.0 or 10.0
EQP-MLPHS	pH Sensor Storage Solution

* x = pH, specify 4.0, 7.0 or 10.0

PART #	DESCRIPTION
EQP-MLM6	M6 pH/Conductivity Meter
EQP-ML512M5	512M5 Conductivity Meter
EQP-MLARH1	TechPro ARH1 Combination Meter
EQP-MLUM6P	Ultrameter 6P



Lithco Press Suckers

Specially formulated for handling even difficult stocks.

- Made from long-lasting rubber
- Eliminates feeding problems
- One dozen press suckers/package



PART #	FITS PRESS/COLLATORS
LIT-PS1	AB Dick, All Models (#66)
LIT-PS2	Ryobi/Itek (#82)
LIT-PS3	Hamada (#78)
LIT-PS6E7	Harris 90 ELB, Mann, Macey Collator & Stitcher – for Paper
LIT-PS6E8	Harris 90 ELB, Mann, Macey Collator & Stitcher – for Cardboard
LIT-PS7	Harris, Giant, Web, Chief for Cardboard
LIT-PS8	Harris, Giant, Web, Chief for Paper
LIT-PS12	Harris 1361 LTN
LIT-PS13A	Miehle CS3122 Feeder, Superchief, Miller, Didde Glaser Collator – for Paper
LIT-PS13B	Miehle CS3124, Superchief, Dexter, Giant – for Cardboard
LIT-PS19	Flat Discs – Specifications Required
LIT-PS19K	ATF 15 (Flat)
LIT-PS22	Heidelberg, Kluge
LIT-PS68	Heidelberg
LIT-PS76R	Muller (Red)
LIT-PS83	Heidelberg GTO
LIT-PS88	Hamada CK 02-77
LIT-PS90	Toko DYY-9-R1, Multi 1218-CJ-11, Imperial CJ-11
LIT-PS92	Heidelberg 22.016.008 TOK – TOM
LIT-PS92Q	Heidelberg Quickmaster and Printmaster
LIT-PS93	Muller 020.1913
LIT-PS99	Heidelberg 42.016.073 – GTO
LIT-PS102	Horizon Collator
LIT-PS103	Horizon Collator
LIT-PS104	Duplo Collator
LIT-PS104A	Bellows Cup for Horizon Collator
LIT-PS105	Bellows Cup for Hamada

SureFoot Sucker



The best sucker you can buy for a small offset press

The SureFoot is a vacuum-operated, telescoping sucker foot specifically designed for small offset presses. Installation takes only minutes, giving your duplicator press the positive pick-up action of larger presses. *Sold in sets of four.*

- Easily handles difficult stocks from onion skin to 12-point board, even in combination
- Three-piece design for user-friendly servicing
- Close manufacturing tolerances for optimum performance
- Strong, self-lubricating plastic for low friction



PART #	DESCRIPTION
MIS-SFMUL	SureFoot for all Multi Presses
MIS-SFABD	SureFoot for all A.B. Dick Presses
MIS-SFRYO	SureFoot for all Ryobi Presses

Lithco Fountain Bottles

High-density, rigid bottle cannot collapse under use

- Positive-flow aluminum valve maintains uniform water level
- Leakproof quart bottle graduated in ounces and easy-to-read ratios on one scale



PART #	DESCRIPTION
LIT-FB1	A.B. Dick
LIT-FB2	Hamada
LIT-FB3	Old Style Multi*, Chief
LIT-FB4	New Style Multi*
LIT-FB5	Ryobi, Itek
LIT-FB1V	A.B. Dick, Valve Only
LIT-FB2V	Hamada, Valve Only
LIT-FB3V	Old Style Multi*, Chief, Valve Only
LIT-FB4V	New Style Multi*, Valve Only
LIT-FB5V	Ryobi, Itek, Valve Only

*Old style water bottle fits directly in fountain pan; new style bottle connects to pan via hose.

- HMIS and product identification spaces to conform to OSHA labeling regulations
- Designed to fit original, manufacturer's water system



Lithco Sheet Separators (Cat's Whiskers)

Keeps press feeding one sheet at a time

- Die stamped from flexible, solid copper
- One dozen Cat's Whiskers/bag

PART #	PRESS
LIT-CW1	Multi/Hamada
LIT-CW2	ATF Chief
LIT-CW3	Ryobi/Itek
LIT-CW4	Davidson



HEIDELBERG SUPPLIES



Heidelberg Ink Fountain Liners

Manufactured to the highest specifications

Fabricated from durable, long-lasting 0.19 mm thick polyester material, they are permanently formed to assure an exact fit. Tested using both conventional and U.V. inks, these liners (also called Ink Duct Foils) offer maximum chemical resistance without any ink duct contamination. Also available are rolls of Adhesive Foam and Two-Band Bi-adhesive Tape for Ink Duct Foil Sensor Protection for presses with C.P.C.

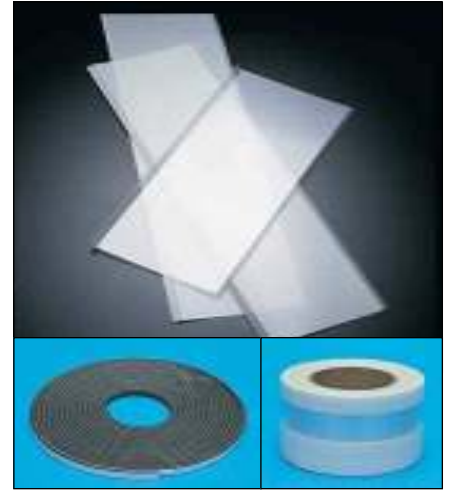

A

B

Heidelberg Wash-Up Blades

Provides quick wash-up performance with no roller damage

Blades consist of stainless steel that is bonded to a chemically-resistant, nitrile rubber edge. Sold two/package.

- Uniform blade-to-roller contact assures efficient cleaning
- Long lasting, wear-resistant, molded rubber tip
- Conforms to "Original Heidelberg" specifications

PART #	PRESS MODEL
MIS-WUBTOK	TOK
MIS-WUBQM	Quickmaster
MIS-WUBGTO46	GTO 46
MIS-WUBGTO52	GTO 52
MIS-WUBKORD62	KORD 62
MIS-WUBKORD64	KORD 64
MIS-WUBMO65	MO 65
MIS-WUBSORK65F	SORK 65-F (Flexible)
MIS-WUBSORK65R	SORK 65-R (Rigid)
MIS-WUBKORS72	KORS-72
MIS-WUBSORDR	SORD-R (Rigid)
MIS-WUBSORDF	SORD-F (Flexible)
MIS-WUBSORS	SORS
MIS-WUBSM52	Speedmaster 52
MIS-WUBSM72	Speedmaster 72
MIS-WUBSM74	Speedmaster 74
MIS-WUBSM102	Speedmaster 102
MIS-WUBSM102CD	Speedmaster 102-CD

NOTE: Wash-Up Blades are available for Heidelberg presses not listed. Please contact your Dealer or Lithco Customer Service for ordering information.

PART #	QUANTITY	FITS HEIDELBERG PRESS MODEL
MIS-FLQM	100	Quickmaster 46 & DI
MIS-FLGTO52	100	GTO 52
MIS-FLMO65	100	MO 65
MIS-FLSM52	100	Speedmaster 52
MIS-FLSM72	100	Speedmaster 72/74/SORMZ
MIS-FLSM102	100	Speedmaster 102/SORS 102
MIS-FLSORD	100	SORD/50
MIS-FLWEB8	50	8-Page Web (with foam)
MIS-FLWEB16	50	16-Page Web (with foam)
MIS-FLWEB110C	50	Web 110C (with foam)
MIS-FLAF	1 Roll	Adhesive Foam – 10m (A)
MIS-FLTBT	1 Roll	Two-band C.P.C. Tape – 25m (B)



Plastic Ink Knives were designed to work with Heidelberg C.P.C. Ink Duct Foils. See page 77 for a wide selection to meet your needs.

Heidelberg Quickmaster Felts & Cloth Rolls

We have replacement products you need for your Heidelberg Quickmaster, manufactured to OEM specifications in the USA.

PART #	DESCRIPTION
MIS-WUF1QM	Wash-Up Felt – 14 7/8" x 1" – no holes
MIS-WUF2QM	Wash-Up Felt – 14 7/8" x 1 7/16" – no holes
MIS-WUF3QM	Wash-Up Felt – 14 7/8" x 2 3/4" – 3 holes
MIS-WUF4QM	Wash-Up Felt – 14 7/8" x 3" – 3 holes
MIS-PCCQM	Plate Cleaner Cloth Roll – metal core
MIS-BCCQM	Back Cylinder Cloth Roll – metal core



Don't think of Impress from Modern Solutions (page 49) as just a Prepress product. It has many great Pressroom and Bindery applications. See Link #P861.

EZskid™

THE solution for using press-ready skids with your Heidelberg S-Line and Speedmaster Presses

Tired of the hassle and risks associated with restacking paper onto your Heidelberg's integrated paper skids? We have THE solution for you. Now you can roll press-ready skids or any pallet directly onto our EZskid platform. The EZskid is constructed entirely of steel, and engineered for fast and easy user installation. The feeder model integrates seamlessly with the factory installed side-lay adjustment system.

- ▶ Reduce turnaround and make-ready times
- ▶ Reduce operator injuries
- ▶ Increase profits

PART #	F/D*	DESCRIPTION
EQP-EZSF	F	EZskid for 40" S-Line and Speedmaster 102
EQP-EZSD	D	EZskid for 40" S-Line

*Feeder or Delivery skid.



Lithco SBT Anti-Marking Sheets

Eliminate ink marking on printed sheets with SBT technology

Lithco SBT Anti-Marking Sheets offer a simple, cost efficient alternative to nets, cylinder texturizing and air drums. Microscopic silicon beads provide an air cushion for the printed sheet during transfer between cylinders. This air cushion reduces friction and sheet drag, which reduces marking on the finished sheet. The reduction in friction allows the press to be operated at higher speeds without sacrificing quality. Paper and Polyester sheets mount easily to the transfer cylinder with spray adhesive or double sided tape. An Adhesive Backed Polyester sheet is also available for cleaner and quicker installation.

- ▶ No equipment or press modifications necessary
- ▶ Mounts quicker and lasts two to three times longer than nets
- ▶ Dimensionally stable
- ▶ Oil and solvent resistant
- ▶ Cleans easily with mild, water miscible press wash
- ▶ Reduces static electricity on the cylinders

PART #	DESCRIPTION
MIS-SBTABPOLxy	SBT AB Polyester – Custom Cut Sheets
MIS-SBTPOLxy	SBT Polyester – Custom Cut Sheets
MIS-SBTAPxy	SBT Paper – Custom Cut Sheets

xy Sold in custom cut sheets. Indicate around by across cylinder dimensions.



Automatic Blanket Cleaning Cloth

For automatic blanket cleaners using cloth technology

This specially designed and engineered cloth is hydroentangled with a polyester layer for the added strength needed to meet automatic blanket cleaning requirements. This provides high wet-strength, even with today's water miscible, low-VOC washes. Color: Blue.

- ▶ No lint
- ▶ Excellent absorbency
- ▶ Sizes to fit all popular presses with ABC technology
- ▶ Manufactured in the USA

PART #	PRESS	SIZE
MIS-ABCKS	Komori Sprint	28" x 6½ Yd.
MIS-ABCKL	Komori Lithrone	29¼" x 6½ Yd.
MIS-ABCK411/2	Komori	41½" x 12 Yd
MIS-ABCHSM52	Heidelberg SM 52	20¼" x 10 Yd.
MIS-ABCHMO	Heidelberg MO	26¾" x 10 Yd.
MIS-ABCHSM74	Heidelberg SM 74	30⅞" x 10 Yd.
MIS-ABCMR700	Man Roland 700	41⅞" x 500 Meters

NOTE: Sold by the case.



Looking for the most comfortable anti-fatigue floor mat?

Try the Barefoot mats found on page 117. Not only are they great to stand on, but also their unique design helps to eliminate must odors by allowing air to circulate under them, making them ideal for Pressrooms.



PLATE PENS



THE PEN PLACE™

Lithco first introduced "Correct-A-Plate™" deletion and addition pens for positive and negative metal plates over twenty-five years ago. We have tested many look-a-likes since then, but none have met the high standards of our originals. Now there are "Correct-A-Plate" pens for electrostatic plates and black plates, such as Silvermaster® and Megalith®. We have also broadened the line to include red and black opaueing pens sold under the name "Correct-A-Neg™" (See page 52).



HELPFUL TIP

To prevent pens from drying out prematurely, keep tightly closed when not in use. Store tip down in a cool location.



Lithco Paper pH Test Pen

Quickly indicates whether paper is acidic or alkaline

- Turns yellow for acid, violet for alkaline
- Aids in balancing fountain solution to the paper stock
- Reduces picking and toning problems especially with vegetable-oil based inks

PART #	DESCRIPTION
CAP-PH	Paper pH Test Pen, Fine Point



HOW TO USE HONES

Dip the hone into fountain solution. Lightly rub the image to be deleted. Make sure the plate is on a hard, flat surface to prevent denting the plate. Finally, buff-out any light scratches with Lithco Pumice on a Webril Wipe, saturated with fountain solution.

CORRECT-A-PLATE ADDITION AND DELETION PENS

PART #	PLATE	TYPE	TIP	USAGE/APPLICATION NOTES
CAP-AF CAP-AB	Metal	Addition	Fine Broad	Works on or off the press. Clean plate with solvent, then dry. Write-in correct image as desired, allow image to dry, then continue run.
CAP-DF CAP-DB	Metal	Deletion	Fine Broad	Removes scratches, scumming, toning and oxidation. Works on the image without affecting the plate coating. Brush-on, wipe off with a damp pad. Deletion is permanent.
CAP-BAF CAP-BAB	Silvermaster®*	Addition	Fine Broad	Add images and correct pin-holes on all types of black plates. Apply to clean plate surface, let dry thoroughly, then continue run.
CAP-SMDF CAP-SMDB	Silvermaster®*	Deletion	Fine Broad	Remove unwanted images from all types of black plates. Apply lightly to remove shadows and cut-marks. Image may remain on plate but will be non-ink receptive.
CAP-ESTATAF	Electrostatic	Addition	Fine	Add images and fill-in pin holes on all electrostatic masters. Make additions prior to etching.
CAP-ESTATDF CAP-ESTATDB	Electrostatic	Deletion	Fine Broad	A quick and easy way to delete images and cut marks from wet-toner, electrostatic masters. Deletion must be done prior to etching plate. Image will remain visible on plate, but will be non-ink receptive.

* Designed to work with all "Black" plates, such as Silvermaster®, Megalith® and Mitusbishi photo direct materials.



Mark-Tex Plate Correction Pens

For metal, Silvermaster or electrostatic plates

Mark-Tex plate correction pens have been favorites in the pressroom for many years. Use either on or off the press.

Dura Paper

The offset friendly synthetic paper

Use for any application where durability and weatherability are key factors. Water, oil, and grease resistant. Print, fold, score, perf and die-cut in any direction.

PART #	DESCRIPTION
LIT-DP1081/211	8½"x 11" 10 Pt.
LIT-DP101117	11" x 17" 10 Pt.

Color White. 100 sheets/Pkg.

PART #	PLATE	TYPE	TIP
MAR-2100	Metal	Addition	Fine
MAR-2101	Metal	Addition	Broad
MAR-2200	Metal	Deletion	Fine
MAR-2201	Metal	Deletion	Broad
MAR-3200	Electrostatic	Addition	Fine
MAR-3100	Electrostatic	Deletion	Fine
MAR-3101	Electrostatic	Deletion	Broad
MAR-4200	Silvermaster	Addition	Fine
MAR-4100	Silvermaster	Deletion	Fine
MAR-4101	Silvermaster	Deletion	Broad

COLORpHAST Indicator Strips

Quick, economical way to monitor fountain solution

These easy to use strips are sensitive to 0.2 pH units. Choose from four different pH ranges.



- Non-bleeding indicator dyes bonded to cellulose
- Safe to use

PART #	PH RANGE
MIS-PHS	0 to 6
MIS-PHS014	0 to 14
MIS-PHS7514	7.5 to 14
MIS-PHS510	5 to 10

Packed 100 strips/box.

SofChek™ Water Hardness Test Strips

Monitor tap water used in fountain solutions and darkroom chemistries to prevent problems



PART #	DESCRIPTION
MIS-SC	SofChek Water Hardness Test Strips

Packaged 50 strips/storage bottle

Lithco Alcohol Testers

EPA regulations make it even more important to monitor alcohol levels in your fountain

- Gives a direct, quick, easy and accurate reading of isopropyl alcohol concentrations
- Comes in a protective carrying tube with pocket clip



PART #	DESCRIPTION
MIS-ALC	Standard Range 0% to 28%
MIS-ALCL	Low Range <1% to 12%

Lithco "Scotch" Honers

This all time favorite of pressmen is back again and readily available

"Scotch" honers are an economical and effective method for removing unwanted images, scratches and oxidation from all types of metal printing plates. Natural, extra-fine grit stone. Approximate length 5½". Made in the USA.

- Non-hazardous
- Soft enough to be easily shaped
- Use on or off the press
- No chemicals to spread to nearby images



PART #	SIZE
LIT-SH1/8	1/8" Honers
LIT-SH1/4	1/4" Honers
LIT-SH3/8	3/8" Honers

Weldon Roberts Retouch Sticks

Weldon Roberts No. 289R Retouch Transfer Stick is a lithographer's tool for work on wet or dry metal plates, glass or stone. Removes shadows and blemishes on positive enlargements. Sharpen in a pencil sharpener for fine, close work. Stick holders also available.

PART #	DESCRIPTION
MIS-289R	Retouch Sticks (20/box)
MIS-289H	Holders



Snake Slips

Fine ceramic for removing unwanted images from metal plates. Easily shaped. Size: ¼" square x 5½" long.

PART #	DESCRIPTION
MIS-SNA	Snake Slips



Never Gone Plate Additive Pencil Rub-n-Run Plate Deletion Pencil

Both of these products are unlike anything you have ever used before!

Solid fiber pencil cannot dry out, giving an indefinite shelf-life. Works on either grained or smooth plates. Easy to use.

- Additive – clean plate with plate cleaner, rub with pencil, dab on ink to corrected area and run
- Deletion – clean plate with plate cleaner, rub with pencil, clean area with fountain solution and run



PART #	DESCRIPTION
MIS-NG	Never Gone Additive Pencil (Red)
MIS-RR	Rub-n-Run Deletion Pencil (Orange)

PRESS ACCESSORIES

Quack™ Anti-Marking Nets and Vintage Quack™ Anti-Marking Nets



Remarkably ink-resistant, these nets stay cleaner longer. They reduce paper waste, delivering optimum anti-marking performance. Easy to install, long lasting they repel water significantly better than other transfer nets. Quack Anti-Marking Nets are flat, non-stretch nets that lie flat against the cylinder. Vintage Quack Nets are traditional rippled, stretch nets that hang loose on the cylinder.



PART #	DESCRIPTION*
KEN-QA	Quack QA-11
KEN-QB	Quack QB-21
KEN-QC	Quack QC-30
KEN-QD	Quack QD-42
KEN-QE	Quack QE-44
KEN-QF	Quack QF-65
KEN-QG	Quack QG-78
KEN-VA17	Vintage Quack VA-17
KEN-VB22	Vintage Quack VB-22
KEN-VC26	Vintage Quack VC-26
KEN-VC30	Vintage Quack VC-30
KEN-VD42	Vintage Quack VD-42
KEN-VE44	Vintage Quack VE-44
KEN-VF60	Vintage Quack VF-60
KEN-VF65	Vintage Quack VF-65
KEN-VG78	Vintage Quack VG-78

*The number following the description is the maximum press width for this size net. Note: Call your dealer or Lithco Customer Service to determine the proper size for your press. Packaged 5 nets/box.



Spin-A-Roll

Industrial strength "lazy susan"

Full circumference ball bearings facilitate changing direction of web rolls without risking back injury. If you run a web, you cannot afford to be without one. Capacity 1500 lb.

PART #	DESCRIPTION
MIS-SAR	Spin-A-Roll



Fount-N-Kleer II Fountain Solution Filter



Unique construction helps reduce foam, will not balloon-out due to high pressure

Fount-N-Kleer II is a self-contained replacement for conventional foam and bag-style filters in continuous dampening units. Its large surface area provides for a higher dirt and ink holding capacity and a finer particulate removal. Equipped with a 1/2" hose barb for retrofitting to existing filtration system.

- Easy to install and change
- Extends fountain solution life
- Decreases fountain maintenance
- Improves product quality

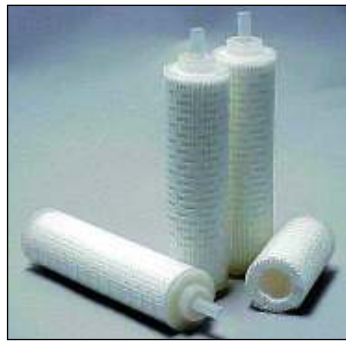

Web Roll Strippers

Save money by using this handy tool instead of a knife

These roll strippers save waste by avoiding damage to the underlying paper. Easy to use, lightweight, durable, and easy to grip. Available in two sizes.

PART #	DESCRIPTION
MIS-RSS	Small Roll Strippers
MIS-RSL	Large Roll Strippers

Fount-N-Kleer Fountain Solution Filtration Kit



Designed to prolong the life of your fountain solution and reduce operating costs

This unique filter removes ink and particulate matter that contributes to poor print quality. All fountain solution is pumped through the filter, substantially reducing contamination.

- Fewer hickies
- Maintain pH and conductivity longer
- Significant reduction in fountain solution consumption
- Prevents cross-contamination of central circulators
- Easy to use and maintain – Built-in pressure gauge
- Improved productivity, quality and customer satisfaction



FKB-20-PG

PART #	DESCRIPTION
PRO-PCT4010Z	Model PCT-40-10Z Fount-N-Kleer II Filter Unit for 40" and under sheet fed presses – 5 gpm max. flow
PRO-FK10PG	Model FK-10-PG Fount-N-Kleer Filter Kit for 29" and under sheet fed and webs – 5 gpm max. flow
PRO-FKB20PG	Model FKB-20-PG Fount-N-Kleer Filter Kit for 30" and up sheet fed and webs running 12+ hours a day – 15 gpm max. flow
PRO-FKHF30PG	Model FKHF-30-PG Fount-N-Kleer Filter Kit for very high volume – 45 gpm max. flow

See chart on page 116 for replacement filters.



Lithco Ink Eaters™

Absorbs many times its weight in ink and will not sink

The Ink Eater is a nylon-mesh bag filled with absorbent material to remove ink from the fountain solution tank in continuous dampeners such as Dahlgren. Special absorbent material attracts ink as it floats in the circulating tank. When saturated, remove and allow to dry before disposal.

- Will not absorb water, gum or other important fountain solution chemicals
- Prevents contamination of the dampening system for fewer problems, less down-time, better quality
- Approximate size: 4" x 8" x 1"

PART #	DESCRIPTION
MIS-IE	Ink Eaters



Roller Guard

Prevents stray paper from getting into ink rollers on A.B. Dick presses

This unique product keeps stray paper out of ink rollers and your job running smoothly.

- Shields press parts that can break down from dripping roller washes and inks
- Can be installed and removed in just seconds
- Guaranteed for six months to save you time and money or your money back

PART #	DESCRIPTION
MIS-RG36	Roller Guard for ABD 350, 360, & 8800 Series
MIS-RG98	Roller Guard for ABD 9800 and 9900 Series

Ionix Static Eliminator

Eliminate static in feeders

Ionix is a patented breakthrough in anti-static technology for sheetfed printers and binderies. It is designed to eliminate static in paper in sheetfeeding air separator mechanisms. It makes your machine's feeder-blower air a paper static eliminator! Perfect for presses, folders, collators and binders.

- Utilizes a unique, patented means of neutralizing static
- Requires no electricity or maintenance – works automatically as air passes through the unit
- Totally non-hazardous – no high voltage or nuclear materials
- Works on any size equipment
- Eliminates static **between** the sheets to facilitate feeding
- Easy to install – takes just minutes



Unconditionally guaranteed to perform for 30 days in the equipment for which it is designed. Warranted for 6 months from date of purchase based on normal use. Replacement is recommended after one year.

IONIX STATIC ELIMINATOR - FOR SHEET-FED PRESSES & FOLDERS*			
FOR MAXIMUM SHEET SIZES UP TO			
11" X 17" PART #	22" X 34" PART #	26" X 40" PART #	HOSE INSIDE DIAMETER
MIS-IO1001	MIS-IO2001	MIS-IO3001	¼"
MIS-IO1002	MIS-IO2002	MIS-IO3002	½"
MIS-IO1003	MIS-IO2003	MIS-IO3003	¾"
MIS-IO1004	MIS-IO2004	MIS-IO3004	1"
MIS-IO1005	MIS-IO2005	MIS-IO3005	1¼"

* For machines other than sheet-fed presses and folders, materials other than paper, sheet sizes larger than 26" x 40", abnormally high static situations (high speed copiers, plastics), blower hoses larger than 1½" diameter, or air pressures greater than 50 PSI, please consult your dealer.

Lithco Static Eliminator Tinsel

An economical way to eliminate static electricity from your equipment. The solid copper core and bristles attract static electricity and safely ground it. Two, 12 yard coils/box.

PART #	DESCRIPTION
MIS-TIN	Tinsel



MARTIN YALE INDUSTRIES

MARTIN YALE INDUSTRIES



For more than 50 years the Martin Yale name has been synonymous with innovation, quality and value. Martin Yale products are designed to meet a variety of graphic arts needs.



B
I
N
D
E
R
Y

Folders

The Heavy-Duty AutoFolder™ and the Air Feed AutoFolder™ both have the following extensive features:

- Slits, scores and perforates (with attachments)
- Operates at a variable speed of up to 18,000 8½" x 11" sheets per hour
- Easy set-up for single folds, letter folds, Z-folds, double parallel folds, baronial folds and French folds
- Adjustable within a fold range of 1¼" to 13" on the first and second fold to allow for customized folds
- Quick release journal shafts facilitate easy set-up for perforating, scoring and slitting
- Includes one 7-tooth per inch perforating wheel and two scoring wheels
- Optional 3- and 14-tooth per inch perforating wheels and slitting wheel also available
- Bottom feed allows for reload of documents without stopping machine



HEAVY-DUTY AUTOFOLDER



AIR FEED AUTOFOLDER SHOWN WITH OPTIONAL ACCUCOUNT

Heavy-Duty AutoFolder™

- Handles sheet sizes from 3½" x 3½" to 14" x 20"
- Handles 9# onion skin to 110# index

Air Feed AutoFolder™

- Handles sheet sizes from 3" x 3¼" to 14" x 18"
- Handles 16# bond to 70# bristol

PART #	MODEL	DIMENSIONS	DESCRIPTION
EQP-MY959	959	43" x 24" x 19.5"	Heavy-Duty AutoFolder
EQP-MY959AF	959AF	43" x 24" x 32"	Air Feed AutoFolder

Business Card Slitters

Available in four configurations

- Two passes produce up to 500 2" x 3½" finished cards in less than three minutes
- Fast and easy adjustment and set-up
- Durable, semi-self sharpening blades
- Off and on feed control
- Friction fed
- Adjustable paper guides
- Pre-spaced blades

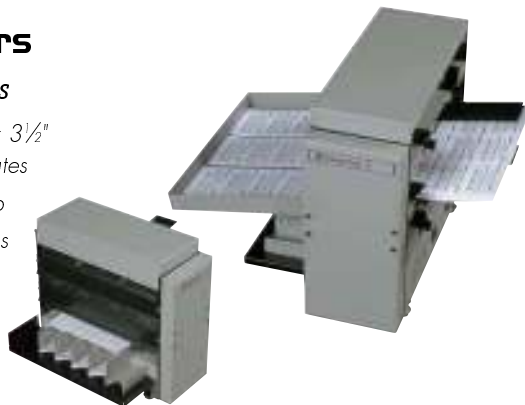

PART #	MODEL	QTY. UP	DIMENSIONS	DESCRIPTION
EQP-MYBCS210	BCS210	10	8" x 6" x 15"	Tabletop 10-Up Business Card Slitter
EQP-MYBCS212	BCS212	12	8" x 6" x 15"	Tabletop 12-Up Business Card Slitter
EQP-MYBCS410	BCS410	10	15" x 6" x 15"	Tabletop 10-Up Business Card Slitter w/Scoring and Perforating
EQP-MYBCS412	BCS412	12	15" x 6" x 15"	Tabletop 12-Up Business Card Slitter w/Scoring and Perforating

Standard electrical is 115v, 60 Hz. 220V, 50 Hz available on some models. Please inquire.

StackWagon™

- Conveniently transfers volumes of paper in mailrooms, offices, print shops, copy shops, schools and hospitals
- Center-slope design ensures that paper rests against the inner stacking walls
- Heavy-duty steel construction
- Some assembly required



500 STACKWAGON



501 STACKWAGON

PART #	MODEL	DIMENSIONS	MAX. SHEET SIZE
EQP-MY500	500	20" x 20" x 44"	8½" x 11"
EQP-MY501	501	20" x 32" x 44"	11" x 17"



AccuCount Electronic Counter

- Easily mounts to folders, perforators and other machines
- Remote optical sensor reads each sheet as it passes
- Each sheet pass is displayed on an LED readout



Paper Drill

- Bores through a 1" stack of paper
- Easy-Dial Auto-Stop provides instant selection of five pre-set drilling positions
- Customize drilling anywhere on sheets up to 11⁵/₈" wide
- Uses J-style drill bits – one 1/4" included
- Accessory kit includes drill removal tools, sharpener, oil stone, pick and tool bag



Other selected Martin Yale parts and equipment are also available.

Commercial Paper Cutter

- Tabletop cutter ideal for photo shops, businesses, schools and small print shops
- Heavy-duty wood base
- Cuts 200 sheets at a time (up to 12" wide, 1¹/₂" thick, 24# bond paper)
- Safety blade latch prevents cutting until released
- Positive clamp holds stack in place, guaranteeing high accuracy cutting



- Adjustable paper guide
- Resharpenable blade changes in minutes

PART #	MODEL	DIMENSIONS	DESCRIPTION
EQP-MY7000E	7000E	20" x 30" x 16"	Commercial Paper Cutter

Joggers

Both Joggers listed below have the following features:

- Helps eliminate static electricity and paper sticking for easier processing
- Great companion for high-speed copiers, folding machines, printing presses, cutters and perforators

Desktop Paper Jogger

- Jogs one ream of 8¹/₂" x 11" or a half-ream of 8¹/₂" x 14" paper

Tabletop Paper Jogger

- Capacity of the laminated wooden tray is 17" x 22" x 3"
- Variable speed control



DESKTOP



TABLETOP

Tabber

- Seals mail pieces with an adhesive tab to create mailings that comply with US Postal requirements
- Reduces cost of mailings by eliminating the need for envelopes
- Handles media 5" x 12" wide up to 1/8" thick
- Process media up to 7,500 pieces per hour
- Accepts 1⁵/₁₆", 7/8" or 3¹/₃₂" round or square tabs with either friction or tractor feed backing
- Accepts rolls of up to 5,000 tabs
- Precision control of tab location

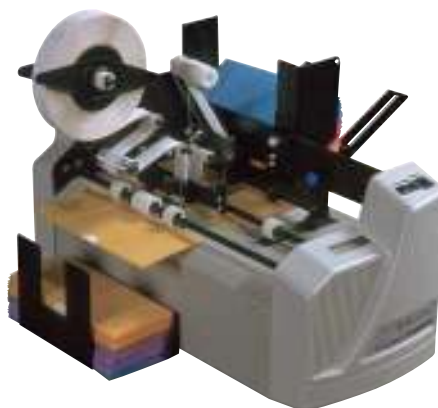

PART #	MODEL	DIMENSIONS	DESCRIPTION
EQP-MYCNTR	CNTR	5 ³ / ₄ " x 3 ⁵ / ₈ " x 2"	AccuCount Electronic Counter
EQP-MY400	400	15 ¹ / ₄ " x 11 ¹ / ₂ " x 15 ¹ / ₄ "	Desktop Paper Jogger
EQP-MY4200	4200	26 ¹ / ₄ " x 17 ¹ / ₂ " x 28 ³ / ₈ "	Tabletop Paper Jogger
EQP-MYEX5100	EX5100	20" x 21" x 17"	Tabber
EQP-MY101	101	20" x 14" x 12"	Paper Drill

Standard electrical is 115v, 60 Hz. 220v, 50 Hz available on some models. Please inquire.

STAPLERS & STAPLES

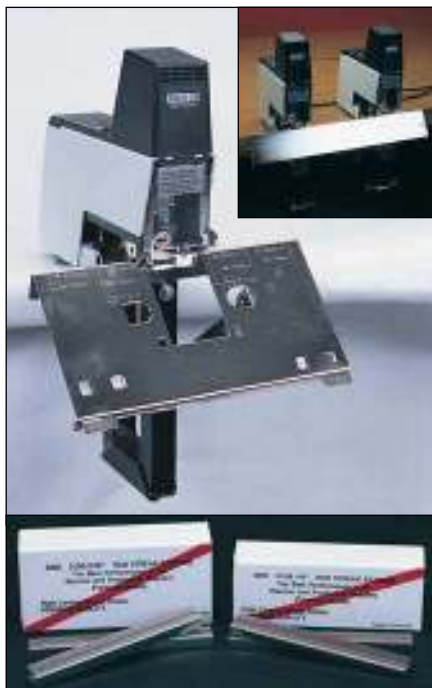

Rapid 106 Electronic Stapler

This multi-purpose stapler quickly pays for itself

Use it flat or as a saddle stapler. Combine two or more to operate side-by-side from one foot-switch with optional Group Stapling Kit(s). Features include:

- ▶ Adjustable stapling power - depth of 40 sheets flat or 20 sheets saddle (20 lb. bond)
- ▶ Operates gently and quietly
- ▶ Lightweight, only 14 lb.
- ▶ Push-button loading, electric foot pedal

PART #	DESCRIPTION
EQP-ST106E	Model 106E Electronic Stapler
EQP-ST106EKIT	Group Stapling Kit
MIS-ST1/4	Box 1/4" Staples, 5000/Box
MIS-ST5/16	Box 5/16" Staples, 5000/Box



PART #	DESCRIPTION
EQP-ST49	Rapid 49 Extra Heavy-Duty Stapler

Rapid 49 Extra Heavy-Duty Stapler

When the job is BIG and THICK, reach for the Rapid 49

Capable of stapling up to 170 sheets of 20 lb. bond with ease. Features a heavy-duty all-steel frame for years of trouble-free operation. The built-in staple crown support assures no bent staples or deformed crowns.

- ▶ The smooth front-loading magazine holds 120 Rapid 9 staples
- ▶ Adjustable stapling depth-from-edge of 1/4" to 3" (6 mm to 75 mm)

Rapid 9 Staples

Quality staples designed for trouble-free operation

Use of the proper staples prevents jam-ups and assures smooth operation of your stapling machine. Use this chart to choose the correct staple for your job and stapler. 5000 per box.

PART #	LEG LENGTH	QTY/BOX	SHEET CAPACITY*
MIS-ST9/8	5/16"/8 mm	5000	5 to 50
MIS-ST9/10	3/8"/10 mm	5000	40 to 70
MIS-ST9/12	1/2"/12 mm	5000	60 to 90
MIS-ST9/14	5/8"/14 mm	5000	80 to 100
MIS-ST9/16	3/4"/17 mm	5000	100 to 130
MIS-ST9/17	7/8"/17 mm	1000	110 to 140
MIS-ST9/20	1"/20 mm	1000	140 to 170

*20 lb. bond, approximately.



Stitching Wire

Your printing jobs deserve only the finest quality stitching wire

Durable and rust resistant, this flexible wire will not crack. Each spool weighs 5 lb.

PART #	DESCRIPTION
MIS-ST20	Round 20 AWG
MIS-ST25	Round 25 AWG
MIS-ST2125	Flat 21 x 25 AWG
MIS-ST2024	Flat 20 x 24 AWG



Stanley Bostitch Staples



These staples are manufactured to Stanley Bostitch specifications for all EHFS Staplers. Use Stanley Bostitch brand for the best performance.

PART #	SIZE
MIS-STSCCR251/4	1/4"
MIS-STSCCR253/8	3/8"
MIS-STSCCR251/2	1/2"
MIS-STSCCR259/16	9/16"

Rapid

Other Rapid Staples, Staplers, and parts are available.

STAPLERS, CORNER CUTTER & PERF BOARD

Skrebba Heavy-Duty Flat & Saddle Stapler



Binds up to 50 sheets

Stapler converts from flat to saddle in seconds. It's powerful, manual lever-action makes assembling manuals, catalogs and brochures almost effortless.

- Dual, adjustable paper guides for accurate positioning of work piece
- Adjustable paper backstop
- Large clamp for mounting to bench
- Use only Skrebba 1/4", 5/16", 3/8" and 1/2" staples listed below

Skrebba Heavy-Duty Long-Reach Stapler



Great for 11" x 17" center stapling

This stapler is ideal for assembling samples of saddle-stapled books up to 150 sheets thick. Useful wherever a long reach or a thick bind is required.

- Fully adjustable throat depth from 1/8" to 10"
- Capacity – 150 sheets 20 lb. bond
- Base dimensions: 3 1/2" wide x 17 1/2" long
- Use only Skrebba staples listed below (all sizes will work)
- Dual stops
- Powerful lever action
- Push-button front loading

PART #	SIZE	SHEET CAPACITY*	DESCRIPTION
MIS-SKFS	N/A	50	Skrebba H.D. Flat & Saddle Stapler
MIS-SKLR	N/A	150	Skrebba H.D. Long-reach Stapler
MIS-SK23/6	1/4"	2 to 15	Skrebba Heavy Duty Staples (1000)
MIS-SK23/8	5/16"	15 to 35	Skrebba Heavy Duty Staples (1000)
MIS-SK23/10	5/16"	30 to 55	Skrebba Heavy Duty Staples (1000)
MIS-SK23/12	5/16"	55 to 75	Skrebba Heavy Duty Staples (1000)
MIS-SK23/17	5/16"	90 to 120	Skrebba Heavy Duty Staples (1000)

*20 lb. bond, approximately.



Score II Perf and Scoring Board



Save bindery costs on short-run jobs

Do your perfining (10 teeth/inch) and scoring right in your shop. Interchangeable and replaceable perfining and scoring wheels perform on coated stock, bond paper and cover stock. Maximum capacity: perf 3-part NCR, or two sheets 20 lb. bond.

- Easily adjustable edge guide
- Full-width guide assures repeatability
- Perfect for sample departments
- Available in two sizes – handles sheets up to 20" or 25" wide
- One year warranty

PART #	DESCRIPTION
EQP-SCORE2	20" Score II Perf and Score Board
EQP-SCORE225	25" Score II Perf and Score Board
EQP-SCORE2SW	Replacement Scoring Wheel
EQP-SCORE2PW	Replacement Perfining Wheel



Use Lithco's One-Step Chain Cleaner and Lubricant inside Drill Bits to prevent chaff buildup.

PART #	DESCRIPTION
EQP-CC	Corner Cutter
EQP-CC1/4	1/4" Replacement Blade
EQP-CC3/8	3/8" Replacement Blade
EQP-CCDIE1	Replacement Die for 1/4" and 3/8" Blades
EQP-CC1/8	1/8" Optional Blade
EQP-CC1/2	1/2" Optional Blade
EQP-CCDIE2	Optional Die for 1/8" and 1/2" Blades



Corner Cutter

Cut up to 1" thick lifts of stock

An excellent machine for creating round corners on literature, business cards, photographs, negatives and plastics. Includes two blades, one 1/4" and one 3/8", and a cutting die which can be used with both blades. Optional 1/8" and 1/2" blades and corresponding cutting die available.

- Extra-long handle for added leverage
- Precision-built, heavy-duty metal construction

DRILL BITS & ACCESSORIES

Lithco Hollow Drill Bits

Manufactured from strong, durable, tool-quality steel

- Hardened the full length of the shaft to resist bending and wobbling
- Larger taper than standard drill bits to prevent chaff build-up
- Available in six styles to fit most popular drills
- Available standard, premium or Teflon® coated



STANDARD DRILL PART #	PREMIUM DRILL PART #	NEW TEFLON DRILL PART #	STYLE	SIZE	NECK LENGTH	DRILL MANUFACTURER
LIT-DBA1/8	—	LIT-DBA1/8T	A	1/8"	3/4"	Casco, Challenge,
LIT-DBA3/16	—	LIT-DBA3/16T	A	3/16"	1 1/4"	Climax, Mark 3 & 4,
LIT-DBA1/4	LIT-DBA1/4P	LIT-DBA1/4T	A	1/4"	2"	Ottawa, Lassco-Spinnit
LIT-DBA5/16	LIT-DBA5/16P	LIT-DBA5/16T	A	5/16"	2"	(2" capacity), Rosback,
LIT-DBA3/8	LIT-DBA3/8P	LIT-DBA3/8T	A	3/8"	2"	SuperSpeed
LIT-DBA1/2	—	LIT-DBA1/2T	A	1/2"	2"	
LIT-DBA1/4L	LIT-DBA1/4LP	LIT-DBA1/4LT	A	1/4"	2 1/2"	
LIT-DBA5/16L	LIT-DBA5/16LP	LIT-DBA5/16LT	A	5/16"	2 1/2"	
LIT-DBA3/8L	—	LIT-DBA3/8LT	A	3/8"	2 1/2"	
LIT-DBJ1/8	—	LIT-DBJ1/8T	J	1/8"	3/4"	Lihit Drill, Martin-Yale
LIT-DBJ1/4	—	LIT-DBJ1/4T	J	1/4"	3/4"	101, SuperSpeed 101
LIT-DBL3/16	—	LIT-DBL3/16T	L	3/16"	1"	Lassco-Spinnit
LIT-DBL1/4	—	LIT-DBL1/4T	L	1/4"	1"	(1" capacity)
LIT-DBL5/16	—	LIT-DBL5/16T	L	5/16"	1"	
LIT-DBL3/8	—	LIT-DBL3/8T	L	3/8"	1"	
LIT-DBK1/4	—	LIT-DBK1/4T	K	1/4"	2"	Martin-Yale, Imperial
LIT-DBK5/16	—	LIT-DBK5/16T	K	5/16"	2"	202, Lihit
—	LIT-DBB1/4P	—	B	1/4"	3 1/2"	Lawson
—	LIT-DBB5/16P	—	B	5/16"	3 1/2"	
—	LIT-DBB1/4LP	—	B	1/4"	4"	
—	LIT-DBB5/16LP	—	B	5/16"	4"	
—	LIT-DBC1/4P	—	C	1/4"	3 1/2"	Nygren-Dahly
—	LIT-DBC5/16P	—	C	5/16"	3 1/2"	

Drill Ease Lube Stick

Eliminate messy sprays

Apply to paper drill bits to facilitate drilling and eliminate burning. The handy stick form allows lube to be applied like a crayon.

PART #	DESCRIPTION
MIS-DE	Drill Ease



Lithco Drill Blocks

Protect your drill bits & your printing

Manufactured from the finest end-grain northern-grown maple, these blocks are precision-milled to fit your paper drill without any sizing problems. Replace drill block at the first sign of wear.

- Useable on both sides for extended wear
- Blocks are 3/4" thick
- Available in packages of 3 or 12 blocks

PART #	DESCRIPTION
LIT-DB1 1/2	1 1/2" Diameter
LIT-DB21 /2	2 1/2" Diameter
LIT-DB3	3" Diameter

BINDER



See our web site for a trouble shooting guide on the causes of drill bit breakage. Link #B961



Lithco Deluxe Drill Bit Sharpener

Sharpens even the dullest bits

Precision-ground, 21-edge, solid carbide burr quickly and easily sharpens hollow drill bits. Compatible with Challenge, Lassco Spinnit, Climax, Large Super Speed, Ottawa or Casco bits with tapered hubs. Easily adapts to Pioneer or Chandler and Price with no additional parts required.



Lithco Drill Bit Sharpener

Just a twist of the wrist is all it takes

Hand-held unit features a solid carbide, 8-blade cutting head. Easy to use, just give the dull bit a few quick twists and it is as good as new. Works on all hollow drill bits.

PART #	DESCRIPTION
MIS-DBSD	Deluxe Drill Bit Sharpener
MIS-DBS	Drill Bit Sharpener

Drill Accessories

These tools make servicing your drill safer and more efficient

- **E-Z Drill Bit Remover** – Removes stuck J or K style drill bits
- **Chuck Key** – Removes stuck A or L style drill bits
- **Chaff Remover** – Clears paper chaff from hollow bits

Pictured above with bits.

PART #	DESCRIPTION	USE ON DRILL BITS
MIS-DBEZR	E-Z Drill Bit Remover	J or K
MIS-DBCK	Chuck Key	A or L
MIS-DBCR	Chaff Remover	All 1/8" and larger



Magnetic Cutter Pads

A must for anyone who cuts carbonless stock

Solve the problem of marking carbonless forms with your cutter clamp. Attach this magnetic-backed foam pad to your clamp to prevent marking. Easy on and off. Two pads/package, each measuring 3" x 15" x 1/4".

PART #	DESCRIPTION
MIS-MCP	Magnetic Cutter Pads

Plastic Drill Blocks

For increased drill life

Two sizes are available to fit Lawson, Challenge and Nygren-Dahly drills. Plastic drill blocks offer several advantages over wood:

- More durable
- Less re-sharpening of bits
- No splintering



PART #	DESCRIPTION
MIS-PDB11/861/2	1 1/8" x 3/8" x 6 1/2"
MIS-PDB11/881/2	1 1/8" x 3/8" x 8 1/2"
MIS-PDB11/885/8	1 1/8" x 3/8" x 8 5/8"
MIS-PDB11/812	1 1/8" x 3/8" x 12"
MIS-PDB11/8121/2	1 1/8" x 3/8" x 12 1/2"
MIS-PDB11/46	1 1/4" x 3/8" x 6"
MIS-PDB11/461/2	1 1/4" x 3/8" x 6 1/2"
MIS-PDB11/412	1 1/4" x 3/8" x 12"
MIS-PDB11/8xx*	1 1/8" x 3/8" x any length
MIS-PDB11/4xx*	1 1/4" x 3/8" x any length

Sold in multiples of three.

* Popular sizes listed. Available in any length. Please specify exact length required. Note: Drill should be adjusted so that the drill tip just touches the block. Drilling too deeply into the block may ruin the block and/or the bit.

Lithco Plastic Cutting Sticks

Made from high-density red vinyl for the ultimate in durability, fit and performance

Computer controlled production methods assure accuracy and consistency, so you can rely on fit and quality from batch-to-batch. They are available for all popular sizes and makes of cutters. Twelve sticks/package. Please use the chart to determine the right size for your cutter.



The following popular cutting sticks are available individually:

PART #	CUTTER	DIMENSIONS
MIS-PCSCH301/2	Challenge	1/2" x 1/2" x 30 1/2"
MIS-PCSCH265/8	Challenge	1/2" x 1/2" x 26 5/8"
MIS-PCSIMP181/2	Imperial	5/16" x 25/32" x 18 1/2"
MIS-PCSTRI227/16	Triumph	9/16" x 9/16" x 22 1/16"

SIZE	MANUFACTURER
1/2" Square	Advance, Challenge, Chandler & Price, Craftsman, Diamond
9/16" Square	Maxima Triumph, Schneider Senator, Itoh*, Schneider *Specify model, dimensions vary
5/8" Square	Miracle
3/4" Square	Como, Dexter-Lawson, National, Oswego, Seybold, Pivano Old Style
3/16" x 3/8" Flat	Polar, Royal Zenith
5/16" x 25/32" Flat	Imperial

Other sizes of cutting sticks are available. Please inquire.

Lithco can provide you with many other sizes, styles, colors and hardness in your plastic cutting sticks. Please inquire if the specific item you require is not listed or shown.

Plastic Knife Guards

Essential safety item for three-knife trimmers

Plastic Knife Guards maximize safety around the paper cutter. They are easily installed, and their magnetic strip holds the guard securely to the knife. **NOTE: Not intended to replace knife board.**

- Guards knives on and off the machine
- Black and yellow safety hazard tape for high visibility
- Constructed of 1/4" thick, heavy-duty polymer



PART #	DESCRIPTION
MIS-PKG16	Plastic Knife Guard – 16"
MIS-PKG22	Plastic Knife Guard – 22"
MIS-PKGxx*	Plastic Knife Guard – any length

* Common sizes are listed. Any custom length available. Specify xx as the guard length. Round up to the next inch for all fractional sizes. Order guard 1" longer than knife. Example, for a 18 1/4" blade, order a 20" guard as MIS-PKG20.

Plastic Jogger Blocks

The efficient, safe way to jog and hold paper in the cutter

Lithco's Plastic Jogger Blocks quickly and safely align paper stock for square, precise cuts.

- Strong magnetic base helps jog bottom sheets perfectly, holds stack against side gauge during cut
- Durable construction holds up under toughest conditions – made of heavy-duty Kimoplastic™ in a perfect 90° angle
- Rounded handle allows a natural grip
- Available in a variety of sizes from 3" (H) x 8" (L) to 6" (H) x 26" (L)



PART #	SIZE* H X L	APPLICATION
MIS-JB38	3" x 8"	For Small Cutters
MIS-JB310	3" x 10"	For Small Cutters
MIS-JB48	4" x 8"	General Use
MIS-JB410	4" x 10"	General Use
MIS-JB412	4" x 12"	General Use

* Larger sizes are available. Please inquire.

PADDING ACCESSORIES



Lithco Padding Compound

Lithco Padding Compound is a water-soluble, vinyl adhesive designed for flexibility and strength. Choose a fast drying speed, or extra-fast dry for high production work. One good coat does the job. Available in red or white. Non-toxic, no VOCs.



Lithco Fan-A-Part Padding Adhesive

A versatile fan apart adhesive for making carbonless sets. Compatible with NCR® and Mead® brands of carbonless papers.

PART #	SIZE	COLOR	DESCRIPTION
CHM-PCRQ	Quart	Red	Fast Dry
CHM-PCRG	Gallon	Red	Fast Dry
CHM-PCWQ	Quart	White	Fast Dry
CHM-PCWG	Gallon	White	Fast Dry
CHM-PCFDWQ	Quart	White	Extra-Fast Dry
CHM-PCFDWG	Gallon	White	Extra-Fast Dry
CHM-FAQ	Quart	Clear	Fan-A-Part
CHM-FAG	Gallon	Clear	Fan-A-Part



Cheesecloth is often used to reinforce the glued edge of pads. See page 113.



Ultra Padding Press

Pad up to 10,000 sheets per hour

This high-capacity padding press handles any tough workload with ease. Its 18" width allows padding a side-by-side stack of 8½" x 11" or a full 11" x 17".

- Professional, heavy-duty clamps allow instant pressure release
- 360° rotation allows high production without having to lift the loaded press or pressure clamp
- Utilizes a minimum of counter space
- One year limited warranty

PART #	DESCRIPTION
EQP-UPP	Ultra Padding Press

ChampPadCo Padding Press

An economical, rugged unit for high production

Press comes complete with base and pressure clamp. Extra pressure clamps are available for high production. Available in three sizes to meet individual shop needs.



PRESSURE CLAMP

PART #	SIZE	DESCRIPTION
EQP-CPC11	11"	ChampPadCo Padding Press
EQP-CPC14	14"	ChampPadCo Padding Press
EQP-CPC22	22"	ChampPadCo Padding Press
EQP-CPC11PC	11"	Pressure Clamp
EQP-CPC14PC	14"	Pressure Clamp
EQP-CPC22PC	22"	Pressure Clamp



Padding Tools

All the padding tools you need from start to finish

No need to search all over for the right padding tools. Everything you need is right here, from pad counters, to brushes, to pad separating knives. Buy the Complete Padding Tool Kit and save.

- Quickie Pad Counter
- Adjustable Pad Counter - 3", 4" or 5" lifts
- 2" Padding Brush - Two per package
- Pad Separating Knife - 3" blade
- Kit consists of 4" Adjustable Pad Counter, two Padding Brushes and a Pad Separating Knife

PART #	DESCRIPTION
LIT-QPC	Quickie Pad Counter
LIT-APC3	Adjustable Pad Counter - 3" Lift
LIT-APC4	Adjustable Pad Counter - 4" Lift
LIT-APC5	Adjustable Pad Counter - 5" Lift
LIT-PB2	2" Padding Brush - 2 per Package
LIT-PSK	Pad Separating Knife
LIT-CPTK	Complete Padding Tool Kit





Lithco Folding Bones

Facilitates hand-folding of paper and cover stock

Lithco Folding Bones are made from genuine bleached bone. Perfect for hand folding large sheets of paper or hand scoring cover stock. Available in 8" and 9" lengths, either pointed one end or rounded both ends. Not made from endangered species or ivory.

PART #	DESCRIPTION
LIT-FBONE8	8" Rounded Both Ends
LIT-FBONE9	9" Rounded Both Ends
LIT-FBONE8P	8" Pointed One End
LIT-FBONE9P	9" Pointed One End

Tacky Finger®

Gives fingers extra grab for sheet-at-a-time accuracy

- Non-irritating
- Non-toxic
- Large, economy size

PART #	DESCRIPTION
MIS-TF	Tacky Finger 2.5 oz.



To give your booklets a professional look, see pages 100-101 for 3L pockets and pages 102-103 for desktop binding equipment.

Lithco Clear Vinyl Book Covers

Add a professional touch to your presentations

Lithco Clear Vinyl Book Covers are an economical way to provide clear, plastic overlay covers on business and legal documents. Compatible with most popular binding systems. Available in letter (8½" x 11") or legal (8½" x 14") size, 100 sheets/package, with square corners. Other sizes available on request.



Now available with rounded corners. Call for details.

Lithco Opaque Vinyl Book Covers



Add an extra touch of class to your binding jobs

Economy and durability in a glossy, opaque white or black, vinyl book cover. Compatible with most popular binding systems. Available in letter (8½" x 11") size, 100 sheets/package, with square corners.

Card-It®

Personalize your presentation with Card-It®

Instantly create "thumb-cut" slots so you can professionally and easily attach your business card to any size paper, brochure or folder. Cuts two perfectly aligned, diagonal slots every time. No staple holes or paper clip marks. Easy to use and very economical.

PART #	DESCRIPTION
MIS-CI	Card-It



PART #	GAUGE	SIZE
VBC-00581/211	.005"	8½" x 11"
VBC-00781/211	.007"	8½" x 11"
VBC-01081/211	.010"	8½" x 11"
VBC-00581/214	.005"	8½" x 14"
VBC-00781/214	.007"	8½" x 14"
VBC-01081/214	.010"	8½" x 14"



PART #	COLOR	GAUGE	SIZE
VBC-W01081/211	White	.010"	8½" x 11"
VBC-B01081/211	Black	.010"	8½" x 11"



3L SELF-ADHESIVE POCKETS

3L CORPORATION



Add value to your customers' print projects with these well-designed, unique, self-adhesive products



SELF-ADHESIVE

Lithco is pleased to be associated with the 3L Corporation of Denmark. Recognized in Europe as an innovative leader in value-added bindery and finishing pressure sensitive pockets and media storage components, these items will generate satisfied customers and increased profits. 3L also manufacturers cold laminate products which require no equipment, heat or electricity – ideal for short run ID badges, menus and luggage tags.

3L Business Card Pockets

No more annoying, unsightly staples to detract from presentations

Business Card Pockets protect inserts while creating a professional image. Adhere the pockets to presentation folders, binders, boxes or just about anywhere.



PART #	U/M	DESCRIPTION	KEY	SIZE
3L-102-10204	100	Side Load	B1	2 ³ / ₈ " x 3 ³ / ₄ "
3L-102-10104	1000	Side Load	B1	2 ³ / ₈ " x 3 ³ / ₄ "
3L-102-10206	100	Top Load	B2	3 ³ / ₄ " x 2 ³ / ₈ "
3L-102-10106	1000	Top Load	B2	3 ³ / ₄ " x 2 ³ / ₈ "
3L-102-10230	100	Top Load with Flap	B3	4 ¹ / ₈ " x 2 ³ / ₈ "
3L-102-10130	1000	Top Load with Flap	B3	4 ¹ / ₈ " x 2 ³ / ₈ "

3L Document Pockets

Locate storage pockets almost anywhere

For the protection and keeping of drawings, cards, instructions, prices and other important documents. Mount on business machines and equipment to hold instructions, service cards and contracts and maintenance records.



3L Corner Pockets

Add a professional, finishing touch to presentation folders

The triangular, self-adhesive Corner Pocket is ideal for use with ring binders, books, folders, catalogs and other printed items.



PART #	U/M	DESCRIPTION	KEY	SIZE
3L-103-10104	1000	Document Pocket (A6)		4 ¹ / ₂ " x 6 ¹ / ₄ "
3L-103-10106	1000	Document Pocket (A5)		6 ¹ / ₄ " x 8 ³ / ₄ "
3L-103-10109	300	Document Pocket (Letter)	D1	8 ⁷ / ₈ " x 11 ³ / ₈ "
3L-100-10103	1000	Corner Pockets		1 ¹ / ₄ " x 1 ¹ / ₄ "
3L-100-10110	1000	Corner Pockets	C1	3 ¹ / ₂ " x 3 ¹ / ₂ "
3L-100-10217	100	Corner Pockets*		6 ¹ / ₁₆ " x 6 ¹ / ₁₆ "

*Designed for letter size.

3L Media Storage Pockets

Keep track of valuable electronic media

Protect valuable CDs, diskettes, ZIP disks, DVDs, Business card CDs (ID-ROM™) and floppy disk surfaces from abrasive dust and dirt. Store or mail your media items in these clear transparent pockets. Easily attach media to job jackets. CD Pockets are available in a variety of configurations including round and square bottoms, with and without tamper-evident seals.



PART #	U/M	DESCRIPTION	KEY	SIZE
3L-105-10107	1000	CD Pocket without Flap	M1	5" x 5"
3L-105-10206	100	CD Pocket with Flap	M2	5" x 5"
3L-105-10106	1000	CD Pocket with Flap	M2	5" x 5"
3L-105-10224	100	CD Pocket w/Tamper Evident Seal – Round	M3	5 ¹ / ₈ " x 5 ⁵ / ₈ "
3L-105-10124	1000	CD Pocket w/Tamper Evident Seal – Round	M3	5 ¹ / ₈ " x 5 ⁵ / ₈ "
3L-105-10126	1000	CD Pocket w/Tamper Evident Seal – Square	M4	5 ¹ / ₂ " x 5"
3L-105-18230	100	CD Pocket w/Flap and Non-Woven Inlay*	M5	5 ¹ / ₁₆ " x 5 ¹ / ₁₆ "
3L-105-18130	1000	CD Pocket w/Flap and Non-Woven Inlay*	M5	5 ¹ / ₁₆ " x 5 ¹ / ₁₆ "
3L-105-10142	1000	Business Card CD Pocket	M6	2 ⁵ / ₈ " x 3 ⁵ / ₈ "
3L-104-10104	1000	Diskette Pocket with Flap	M7	4 ¹ / ₈ " x 3 ¹ / ₂ "
3L-104-10204	100	Diskette Pocket with Flap	M7	4 ¹ / ₈ " x 3 ¹ / ₂ "
3L-104-10124	1000	Diskette Pocket without Flap	M8	4 ¹ / ₈ " x 3 ¹ / ₂ "
3L-104-10106	1000	ZIP Pockets	–	4 ¹ / ₁₆ " x 4 ¹ / ₂ "

*Holds up to three disks or two disks plus an insert.

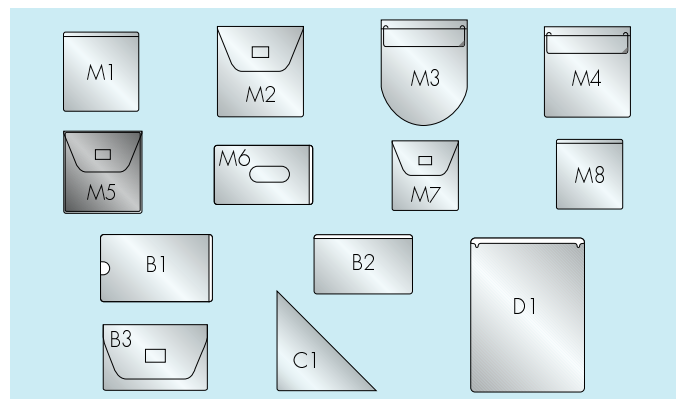

3L SELF-LAMINATING POCKETS

3L Self-Laminating Cards

Laminate without machines, heat or electricity

Conveniently laminate business cards, membership cards, menus, drawings, instruction cards and more without investing in expensive machinery. Made from a mixture of polypropylene and rigid PVC.



3L products are manufactured from environmentally friendly, high optical clarity, adhesive-backed polypropylene (unless noted otherwise). Polypropylene is advantageous to vinyl:

- Resists dry toner transfer
- Copy-safe, flexible, shatter-free, durable and less expensive
- Durable seams resist tearing and splitting
- Archival



PART #	U/M	FORMAT	GAUGE	INSERT MAX.	OVERALL SIZE
3L-170-50809	100	Credit Card	15+5 mil	1 ³ / ₄ " x 2 ⁷ / ₈ "	2 ¹ / ₈ " x 3 ³ / ₈ "
3L-170-50821	100	Bus. Card	12+4 mil	2 ¹ / ₈ " x 3 ¹ / ₂ "	2 ¹ / ₂ " x 3 ⁷ / ₈ "
3L-170-50822	100	Lg. Bus. Card	12+4 mil	2 ¹ / ₄ " x 3 ¹ / ₂ "	2 ⁵ / ₈ " x 3 ¹⁵ / ₁₆ "
3L-170-50837	100	Med. Card	12+4 mil	3 ⁵ / ₈ " x 4 ⁵ / ₈ "	4" x 5"
3L-170-50841	100	A6	12+4 mil	4 ¹ / ₈ " x 5 ⁷ / ₈ "	4 ⁵ / ₈ " x 6 ⁵ / ₁₆ "
3L-170-50851	100	A5	12+4 mil	5 ³ / ₄ " x 8 ¹ / ₄ "	6 ⁵ / ₁₆ " x 8 ³ / ₄ "
3L-170-50857	100	Letter	12+4 mil	8 ¹ / ₂ " x 11"	9 ¹ / ₈ " x 11 ⁵ / ₈ "



Visit web link #B1011 to learn even more about the 3L product line.



3L Media Pockets make the perfect addition to Lithco Job Jackets. See page 118.



3L Self-Laminating ID Badges & Luggage Tags

Laminate ID badges and luggage tags without the need for a heat lamination machine. A sturdy clip is available to attach the ID badge. A heavy-duty plastic loop is available for attaching the luggage tags. Made from a mixture of polypropylene and rigid PVC.



PART #	U/M	FORMAT	GAUGE	INSERT MAX.	OVERALL SIZE
3L-171-50807	100	Luggage tags	13+5 mil	2 ¹ / ₈ " x 3 ⁵ / ₈ "	2 ¹³ / ₁₆ " x 4 ¹ / ₂ "
3L-171-50806	1000	Luggage tags	13+5 mil	2 ¹ / ₈ " x 3 ⁵ / ₈ "	2 ¹³ / ₁₆ " x 4 ¹ / ₂ "
3L-171-50805	100	ID Badges	13+5 mil	2 ¹⁵ / ₁₆ " x 4 ¹ / ₈ "	3" x 4"
3L-171-50804	1000	ID Badges	13+5 mil	2 ¹⁵ / ₁₆ " x 4 ¹ / ₈ "	3" x 4"
3L-171-00192L	100	Plastic Loops for Self-Laminating Luggage tags			
3L-171-00192	1000	Plastic Loops for Self-Laminating Luggage tags			
3L-171-00191L	100	Clips for ID Badges			
3L-171-00191	1000	Clips for ID Badges			



3L Self-Laminating Sign Holders

Ideal for temporary signs

Repositionable mounting adhesive on the backside allows these sign holders to be removed without damage to most surfaces. Great for meeting location notices, new product announcements, trade shows and retail store sale specials.



PART #	U/M	DESCRIPTION	FORMAT	GAUGE	INSERT MAX.	OVERALL SIZE
3L-170-54835	100	Self-Lam. Sign Holder	Med. Size	8+4 mil	3 ⁵ / ₈ " x 4 ³ / ₄ "	4" x 5"
3L-170-54855	100	Self-Lam. Sign Holder	Letter	8+4 mil	8 ¹ / ₂ " x 11"	9 ¹ / ₈ " x 11 ⁵ / ₈ "



PVC and additional sizes, gauges, and repositionable adhesive pouches are also available. Other 3L products not shown include: **Filing Pockets, Label Holders, Shelving Label Holders, Filing Strips, Clip Strips, Index Strips and Index Tabs.** Many 3L products can be produced on a roll for automated application. Volume pricing is available.

FINISHING EQUIPMENT

PDI PC 2000 Tabletop Punch & Coil Inserter

Lightweight, portable and economical

This manual punch easily handles twelve sheets of 20# bond.

- Open ended 11" punching edge for larger books
- Capable of binding up to a 1/4" coil
- Patented lexan coil insertion guide
- One year limited warranty
- All metal construction



PDI Modular Binding Systems

- PDI OD 4000 Electric Punch
- PDI OD 4800 Manual Punch

The Swiss Army Knife of binding

This amazing punch accepts twelve optional interchangeable dies that cover all standard binding punching requirements. An optional binding module (shown below left) converts it into a complete binding system.

- Unique die pin retainer system holds pins in correct alignment and prevents their falling out when changing dies
- Registration system assures accurate hole placement on an 11" sheet regardless of die being used
- Punching capacity of seventeen sheets of 20# bond
- Uses 11 3/4" or A4 dies with open sides for wider sheet capacity
- Smooth, quiet operation
- Dies change quickly without the need of tools
- Model OD 4000 activated by either foot pedal or side guide micro-switch and has auto-jam, auto-reverse feature



B
I
N
D
E
R
Y

➤ Combo Binding Modules

For comb, wire or spiral binding

These three different modules allow for maximum flexibility from your OD 4000 or 4800 Punch and Binding System. Sold individually.



PART #	DESCRIPTION
EQP-PDIPC20004*	Punch & Coil Inserter - 4 pitch
EQP-PDIOD4000*	Electric Punch with Die ^{1,2}
EQP-PDIOD4800	Manual Punch with Die ^{1,2}
EQP-PDIOD4200	Wire-closer Module
EQP-PDIOD4300*	Coil-inserter Module
EQP-PDIOD4400	Comb-opener Module
EQP-PDIOD4xyz-A	Extra Die for OD 4000/4800 ²

* Electrical requirements 115V AC, 60 Hz.
¹ Please specify die when ordering. ² A complete listing of available die punch patterns and part numbers may be found on our **website link #B1021**.

Counting Scales

Stop wasting time counting paper

Hand-counting paper is one of the most time consuming and least profitable tasks in the print shop. These scales can turn a time consuming job into a short term one...and do it far more accurately. Check out these features:



- Designed for cost-conscious users
- Counts paper from business card size up to 11" x 17"

- Sample sizes of 5, 10, 25, 50, 100 or random number user-selectable
- Determines individual piece weight for bulk mailings
- Accumulating subtotal up to 120,000 pieces
- Tare function permits counting in bags or boxes
- Can also be used as an ink mixing scale
- Operates on supplied AC adaptor or batteries
- Easy to read LCD display
- Dual windows show weight and count simultaneously
- Limited two-year warranty on parts and labor

PART #	MODEL	CAPACITY/ RESOLUTION (Lb.)	CAPACITY/ RESOLUTION (Kg.)
EQP-ADHC3KB	HC-3KB	6 lb. x 0.001 lb.	3 kg. x 0.5 g
EQP-ADHC6KB	HC-6KB	12 lb. x 0.002 lb.	6 kg. x 1.0 g
EQP-ADHC12KB	HC-12KB	30 lb. x 0.005 lb.	12 kg. x 2.0 g

Office Combi UniCoil® Document Finishing System



Single efficient unit – no add-on modules

This system radically simplifies the plastic spiral finishing process by combining document punching, UniCoil® insertion and crimping into a single, efficient tabletop unit. It is equally at home in business offices or central reproduction departments where convenience and ease-of-use are a must.

- Patented UniCoil® insertion system
- Punches up to twelve sheets of 20# bond with the push of a button
- Built-in powered paper alignment pins hold loaded pages in perfect position for UniCoil® insertion
- UniCoil® element feeds automatically and is spun into the pre-punched pages
- Cut and crimp ends with the push of a button



UniCoil® PC200 2-Sided Automatic Crimper



Designed for high production work

Works in conjunction with any cut-to-length element plastic spiral inserter to improve production. Cuts and crimps both ends of the Uni-Coil spiral element simultaneously.

- Utilizes two "perfect crimp" modules that easily adjust to various plastic spiral sizes with the turn of a dial
- Standard foot pedal allows two-handed operation
- Coil capacity of 6 mm to 20 mm from 3¾" to 12"
- Easy-to-use – no special training



PART #	DESCRIPTION
EQP-JBOC*	Office Combi
EQP-JBPC200*	PC200 Automatic Crimper

* Electrical requirements 110V, 60 Hz

UniCoil Plastic Spiral Elements



The perfect mate for your Office Combi and other cut-to-length coil bindery equipment

Available in boxes of 100 units, 12" in length in Black (K), White (W), Red (R), Navy Blue (B) and Forest Green (G). 4:1 Pitch.



PART #	DESCRIPTION
EQP-JBUC6x	6 mm UniCoil Spirals
EQP-JPUC8x	8 mm UniCoil Spirals
EQP-JBUC10x	10 mm UniCoil Spirals
EQP-JBUC12x	12 mm UniCoil Spirals
EQP-JBUC14x	14 mm UniCoil Spirals
EQP-JBUC16x	16 mm UniCoil Spirals

x Please specify color from list above. Example: EQPJBUC6R for Red.



Electrically punch up to 12 sheets, and place on paper alignment pins for finishing.



Lower guide comb and insert UniCoil® into feed for simple automatic insertion.



Finish the process with a powered crimp/cut on both ends of the UniCoil-bound document.

Wire-O® Binding Elements



For use with Wire-O® binding machines

Wire binding elements for all machines utilizing the Wire-O® 3:1 pitch with 32 loops. Available in Black (K), White (W), Blue (B), Green (G), Red (R), and Pewter (P), in a variety of diameters, 100 elements/box.



PART #	DESCRIPTION
EQP-JBWO1/4x	¼" Wire-O Elements
EQP-JBWO5/16x	⅝" Wire-O Elements
EQP-JBWO3/8x	⅜" Wire-O Elements
EQP-JBWO7/16x	⅞" Wire-O Elements
EQP-JBWO1/2x	½" Wire-O Elements
EQP-JBWO9/16x	⅞" Wire-O Elements

x Please specify color from list above. For example: EQPJBWO5/16K for Black.

DISPOSABLE GLOVES



Lithco Shur-Fit Disposable Vinyl Gloves

The optimum blend of comfort, sensitivity, fit, and protection

Made of virgin vinyl, SHUR-FIT gloves have been specially compounded to be softer and more flexible, yet resist tears and ruptures. Lightly powdered, they feature built-in stretch for easy on and off. The seamless construction offers excellent resistance to prepress and press room chemicals. Available in four sizes and interchangeable for either hand. *Medical grade only...they are guaranteed to do the job or you get your money back.*



Lithco Embossed Poly Gloves

Embossing gives the user distinct advantages...increased sensitivity, cooler than flat plastic and a firmer grip. Additionally, they are sanitized, offer protection from chemicals and eliminate fingerprint transfer. Available in three sizes and interchangeable for either hand. Sold in handy packages of 100 gloves or economical bulk packs of 1000.

Lithco Disposable Nitrile Gloves

Nitrile is more chemically resistant than vinyl or latex



These tough durable gloves provide added protection from punctures and tears, and they are only 4 mil thick so they offer extra sensitivity and comfort. Beaded cuff for easy on and off. Allergy free. Note: Due to sizing differences, we recommend ordering a size larger than your normal disposable gloves.

PART #	DESCRIPTION	QUANTITY	SIZE
GLV-VS	Lithco Shur-Fit Disposable Vinyl Gloves	100	Small
GLV-VM	Lithco Shur-Fit Disposable Vinyl Gloves	100	Medium
GLV-VL	Lithco Shur-Fit Disposable Vinyl Gloves	100	Large
GLV-VXL	Lithco Shur-Fit Disposable Vinyl Gloves	100	X-large
GLV-PS	Lithco Embossed Poly Gloves	100	Small
GLV-PSB	Lithco Embossed Poly Gloves, Bulk	1000	Small
GLV-PM	Lithco Embossed Poly Gloves	100	Medium
GLV-PMB	Lithco Embossed Poly Gloves, Bulk	1000	Medium
GLV-PL	Lithco Embossed Poly Gloves	100	Large
GLV-PLB	Lithco Embossed Poly Gloves, Bulk	1000	Large
GLV-NS	Lithco Disposable Nitrile Gloves	100	Small
GLV-NM	Lithco Disposable Nitrile Gloves	100	Medium
GLV-NL	Lithco Disposable Nitrile Gloves	100	Large
GLV-NXL	Lithco Disposable Nitrile Gloves	100	X-Large

Jomac Brand Heavy-Duty Disposable Green Vinyl Gloves

Heavy-duty, yet affording plenty of "feel," these gloves protect against everything from ink-covered rollers and dirty dampening covers, to full scale press wash-ups.



Jomac Brand Nitrile Disposable Gloves

A form fitting, lightly textured, sure surface glove, offering superior protection. They have a higher resistance to tearing, punctures and chemicals than either latex or vinyl gloves.

PART #	DESCRIPTION	QUANTITY	SIZE
JOM-GVGM100	Jomac Brand H.D. Disposable Green Vinyl Gloves	100	Medium
JOM-GVGM300	Jomac Brand H.D. Disposable Green Vinyl Gloves	300	Medium
JOM-GVGL100	Jomac Brand H.D. Disposable Green Vinyl Gloves	100	Large
JOM-GVGL300	Jomac Brand H.D. Disposable Green Vinyl Gloves	300	Large
JOM-ND100S	Jomac Brand Nitrile Disposable Gloves	100	Small
JOM-ND100M	Jomac Brand Nitrile Disposable Gloves	100	Medium
JOM-ND100L	Jomac Brand Nitrile Disposable Gloves	100	Large



Looking for gloves for the darkroom or paper handling? See pages 47 and 48 for a full line of cotton, nylon and anti-static gloves.

GLOVES & SPILL PREVENTION

Lithco Neoprene Gloves

Perfect for press wash-ups, deep-etch plate processing or processor cleaning

These heavy duty gloves protect hands from exposure to most petroleum products, caustics and acids. Textured palm and fingers provide a non-slip grip.

Color: Black. Length: approximately 11". Three sizes available.



PART #	DESCRIPTION	QUANTITY	SIZE
GLV-NPM	Lithco Neoprene Gloves	Pair	Medium
GLV-NPL	Lithco Neoprene Gloves	Pair	Large
GLV-NPXL	Lithco Neoprene Gloves	Pair	X-Large

Jomac Brand Nitrile Gloves

Nitrile rubber is highly chemically-resistant and resists punctures and tears for a longer life. This flexible glove has an embossed diamond-tread design to give you a safe, sure grip when handling slippery items. Bright green color for high visibility makes them extraordinarily safe for working near moving machinery parts.



Jomac Brand PVC Coated Gloves

PVC offers tough, flexible, liquid-proof protection plus superior resistance to abrasion. PVC gloves provide protection against most industrial chemicals including acids, alkalis, oils and petroleum distillates. An exceptional glove for the pressroom, it is highly flexible, shaped for working ease and fully textured to provide a non-slip, sure-grip. Color: green.



PART #	DESCRIPTION	QUANTITY	SIZE
JOM-GLG8	Jomac Brand Nitrile Gloves	Pair	X-Small
JOM-GLG9	Jomac Brand Nitrile Gloves	Pair	Small
JOM-GLG10	Jomac Brand Nitrile Gloves	Pair	Medium
JOM-GLG11	Jomac Brand Nitrile Gloves	Pair	Large
JOM-ND100S	Jomac Brand Nitrile Disposable Gloves	100	Small
JOM-ND100M	Jomac Brand Nitrile Disposable Gloves	100	Medium
JOM-ND100L	Jomac Brand Nitrile Disposable Gloves	100	Large
JOM-GL6112	Jomac Brand PVC Coated Gloves	Pair	Large

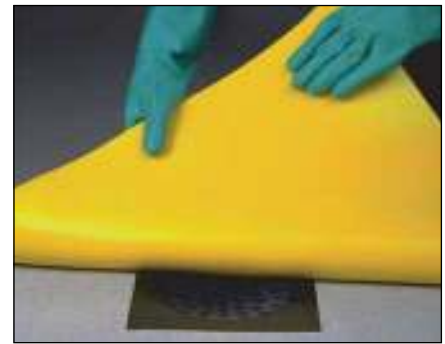

Jomac Brand Drain Covers & Spill Control Drain Plugs



Prevent accidental spills from entering your drains and the Sewer system

Manufactured from high-quality PVC, these Drain Covers and Plugs are sticky, soft and pliable, enabling them to adapt to uneven surfaces to ensure a tight fit.

- Drain Covers are 1/2" thick and available in four large sizes
- The Drain plug's conical shape and easy-hold eyebolt provide easy installation and removal – available in three convenient sizes to fit drains with 2", 3", and 4" diameters
- Both can be cleaned and reused



PART #	SIZE	DESCRIPTION
JOM-DC18	18" x 18"	Jomac Drain Covers
JOM-DC24	24" x 24"	Jomac Drain Covers
JOM-DC36	36" x 36"	Jomac Drain Covers
JOM-DC42	42" x 42"	Jomac Drain Covers
JOM-DP2	2" Dia.	Jomac Drain Plugs
JOM-DP3	3" Dia.	Jomac Drain Plugs
JOM-DP4	4" Dia.	Jomac Drain Plugs

S
A
F
E
T
Y



Plunger Cans

The best way to handle flammable liquids used in "sponging" and cleaning applications. Can has spring-loaded plunger with perforated-metal, fire-baffle dasher. Depressing dasher moistens rag or sponge while surplus drains back into can. Powder coat finish is fire engine red for high visibility.



JUS-10208

Safety Cans

Fire protective, in-plant storage of flammable liquids. All models have double-wire mesh flame arresters for fastest pour-through and leak-tight, self-closing spouts for automatic pressure relief. Metal cans are heavy-duty coated steel with double-seamed construction. Powder coat finish is fire engine red for high visibility. Non-metallic cans are made from inert, high density polyethylene.



JUS-10801
TYPE I



JUS-10828
TYPE II



JUS-14501
POLYETHYLENE

Oily Waste Cans

Essential wherever solvent-soaked cloths and rags are used. Self closing lids keep cans closed when not in use. Round construction and elevated bottom encourage circulation of air around can to dispense heat and prevent spontaneous combustion. Powder coat finish is fire engine red for high visibility.



JUS-9100

JUSTRITE®



Start using America's most widely used handling system for hazardous liquids

JUSTRITE's S.T.U.D. – Storage, Transfer, Use, and Disposal – system of products provide everything you need to safely manage hazardous materials. Long regarded the premier manufacturer of safety products for the storage and dispensing of flammable liquids, JUSTRITE® and Lithco team up to offer these well designed, well known safety products for you.

PLUNGER CANS

PART #	DESCRIPTION	SIZE	APPROV *
JUS-10008	Plunger Can – 4 ⁷ / ₈ " O.D. x 6" High, Dasher 2 ³ / ₄ " diameter	1 Pt.	FM
JUS-10108	Plunger Can – 7 ¹ / ₄ " O.D. x 6" High, Dasher 5" diameter	1 Qt.	FM
JUS-10143	Plunger Can – 4 ³ / ₄ " O.D. x 8 ¹ / ₄ " High, Dasher 5" diameter	2 Pt.	FM
JUS-10208	Plunger Can – 7 ¹ / ₄ " O.D. x 8" High, Dasher 5" diameter	2 Qt.	FM
JUS-10308	Plunger Can – 7 ¹ / ₄ " O.D. x 11" High, Dasher 5" diameter	1 Gal.	FM

SAFETY CANS

PART #	DESCRIPTION	SIZE	APPROV *
JUS-10301	Metal Safety Can Type I – Single Fill/Pour Opening	1 Gal.	FM/UL
JUS-10501	Metal Safety Can Type I – Single Fill/Pour Opening	2 Gal.	FM/UL
JUS-10527	Metal Safety Can Type II – Separate Fill/Pour Openings	2 Gal.	FM/UL
JUS-10801	Metal Safety Can Type I – Single Fill/Pour Opening	5 Gal.	FM/UL
JUS-10828	Metal Safety Can Type II – Separate Fill/Pour Openings	5 Gal.	FM/UL
JUS-14140	Polyethylene Safety Can Type I – Single Fill/Pour Opening	1 Gal.	FM
JUS-14251	Polyethylene Safety Can Type I – Single Fill/Pour Opening	2 ¹ / ₂ Gal.	FM/UL
JUS-14501	Polyethylene Safety Can Type I – Single Fill/Pour Opening	5 Gal.	FM/UL

OILY WASTE CANS

PART #	DESCRIPTION	SIZE	APPROV *
JUS-9100	Oily Waste Can – Foot Operated Cover – Self-closing	6 Gal.	FM/UL
JUS-9300	Oily Waste Can – Foot Operated Cover – Self-closing	10 Gal.	FM/UL
JUS-9500	Oily Waste Can – Foot Operated Cover – Self-closing	14 Gal.	FM/UL
JUS-9700	Oily Waste Can – Foot Operated Cover – Self-closing	21 Gal.	FM/UL



*** DID YOU KNOW...**
Justrite has garnered the most extensive approval ratings in the industry.

FM = Factory Mutual, UL = Underwriters' Laboratories,
N = National Fire Protection Association Code 30,
O = Complies with OSHA, U = Complies with Uniform
Fire Code, N/A = Not Applicable



Flammable Liquid Cabinets

Safe and convenient storage for your flammable liquids

These small size safety storage cabinets are especially well suited for use in small to medium size print shops. Welded double-wall construction with 3-point lock, self-latching door closure, leveler feet, 1½" air space and 2" leakproof sill. Available with manual or self-closing doors. Yellow enamel finish.

NOTE: Many states, including California require self-closing doors. Check your local code before ordering.



Polyethylene Dispenser Bottles

Reduce hazards with this spill-proof dispenser bottle



This dispenser bottle features a unique self-closing ball valve for safer, smoother dispensing of liquids. Polyethylene and stainless steel construction.

SELF-CLOSING CABINETS

PART #	DOORS	SIZE	CAPACITY	APPROV*
JUS-25712	1	35" x 23¼" x 18"	12 Gal.	FM/N/O/U
JUS-25302	2	44" x 43" x 18"	30 Gal.	FM/N/O/U
JUS-25452	2	65" x 43" x 18"	45 Gal.	FM/N/O/U
JUS-25602	2	65" x 34" x 34"	60 Gal.	FM/N/O/U

MANUAL CLOSING CABINETS

PART #	DOORS	SIZE	CAPACITY	APPROV*
JUS-25710	1	35" x 23¼" x 18"	12 Gal.	FM/N/O
JUS-25300	2	44" x 43" x 18"	30 Gal.	FM/UL/N/O
JUS-25450	2	65" x 43" x 18"	45 Gal.	FM/UL/N/O
JUS-25600	2	65" x 34" x 34"	60 Gal.	FM/N/O

PART #	DESCRIPTION	SIZE
JUS-14009	Polyethylene Bottle w/Self-Closing Flex. Dispensing Tube	16 Oz.
JUS-14011	Polyethylene Bottle w/Self-Closing Flex. Dispensing Tube 	32 Oz.

JUSTRITE cabinets comply with OSHA regulations, are designed to meet NFPA Standard 30, and most have been tested and approved by Factory Mutual Research and/or Underwriters Laboratories.

Bench Cans

The safe way to clean small parts in solvent. Place work on spring-loaded, perforated dasher plate, press down and agitate, then release to return dasher to drain position. Dasher acts as flame arrester. Hinged cover minimizes evaporation loss, provides for cleaner environment. Optional parts basket available.



Spill Containment Pallets

These pallets are designed to keep personnel safe from accidental slips due to spills or leaking drums. Also limits exposure to potentially hazardous chemicals and reduces clean-up costs from spills. Designed to hold heavy loads. Wide forklift pockets allow easy relocation. Big sump captures spills and meets UFC and EPA spill containment regulations.

PART #	DESCRIPTION	COMPLIANCE
JUS-28234	2-Drum In-Line Spill Containment Pallet	EPA, UFC
JUS-28254	4-Drum Square Spill Containment Pallet	EPA, UFC



PART #	DESCRIPTION	SIZE	APPROV*
JUS-10295	Bench Can, 9⅝" OD x 3¼" H, plated steel dasher 7½" diameter	2 Qt.	FM
JUS-10370	Bench Can, 9⅝" OD x 4½" H, plated steel dasher 7½" diameter with Parts Basket	1 Gal.	FM
JUS-10375	Bench Can, 9⅝" OD x 4½" H, plated steel dasher 7½" diameter	1 Gal.	FM
JUS-10575	Bench Can, 11½" OD x 5⅞" H, plated steel dasher 9¾" diameter	2 Gal.	FM
JUS-11171	Parts Basket, ½" H x 6¼" diameter	N/A	N/A



Other Justrite and Gator brand items are also available.



E•A•R®s Classic Hearing Protectors

Provides an economical way to protect your ears from harmful noise levels. Made from soft, comfortable, closed-cell polymer foam. Easy to use, simply roll tightly and insert in ear. Noise Reduction Rating (NRR) is 35 decibels when used as directed. A must for all plant employees and guests. The original, yellow color...still the best.



Splashproof Chemical Goggles

Fog-free for added safety and vented for comfort

Don't make the mistake of using improper, perforated goggles when handling chemicals - your eyes need proper protection. Specifically designed to be worn when handling hazardous chemicals.

PART #	DESCRIPTION
MIS-GOGGLE	Splashproof Chemical Goggles
MIS-EAR	E•A•R's Classic Hearing Protectors
MIS-NDM	Nuisance Dust Masks

Lithco Printer's Hazmat Spill Kit



Designed for the small-to-medium size printer to comply with OSHA requirements

This essential spill kit contains everything you need to absorb up to seven gallons of non-aggressive, hazardous material. Packaged in a UN/DOT approved six-gallon plastic drum with a screw-on lid. The kit contains*:

- Absorbent socks – 3 each
- Absorbent pads – 8 each
- Absorbent pillow – 1 each
- Fog-free safety goggles – 1 pair
- Nitrile gloves – 2 pair
- Hazardous Waste label – 1 each
- Disposal bag, 4 mil 20" x 30" – 1 each



PART #	DESCRIPTION
LIT-HSK	Printers Hazmat Spill Kit*

* Individual replacement items available.

Jeff's Printer's Apron

Designed specifically with printers in mind

Jeff's printers apron is not only loaded with features, it is manufactured from high-quality heavy-duty, durable blue denim that is comfortable to wear. All pockets are double stitched for long life. The apron features special pockets designed to hold a 12" or 18" pica stick, pen and pencil, as well as three general-purpose utility pockets.

PART #	DESCRIPTION
LIT-PAS	Jeff's Blue Denim Printer's Apron



Lithco Nuisance Dust Masks

Protects against spray powder, paper lint, dust and dirt

Here is your simple solution to eliminating breathing airborne and nuisance particulates. Handy in the pressroom and bindery. Provides protection while doing maintenance work. *This dust mask is not intended as a respirator or for use around hazardous vapors, mists or dusts. Not NIOSH approved.* Mask has an elastic headband and flexible metal stay over bridge of nose. Sold in packages of 50.



PUMPS & FAUCETS/WASH-UP BOTTLES



Rieke® Metal Pumps

Heavy duty construction guarantees outstanding performance

All internal parts are steel or zinc plated for prevention of chemical reaction. External parts are zinc-plated to prevent rusting and corrosion. Self-venting. Not recommended for use on water-based products.

PART #	DESCRIPTION	DISPENSES
MIS-PUMM45	5 to 6 Gallon Pail Pump	Approx. 4 oz./Stroke
MIS-PUMM855	30 to 55 Gallon Drum Pump	Approx. 8 oz./Stroke



Plastic Siphon Pumps

Long-lasting and reliable

Made of flexible, unbreakable, corrosion-resistant polyethylene. Operates as a siphon or pump with a steady, even flow. No-drip discharge hose. The ideal choice for dispensing inorganic acids, fountain solutions, developers, fixers and other inorganic graphic arts chemicals.

PART #	DESCRIPTION
MIS-PUM905	1 to 5 Gallon Cans
MIS-PUM901	30 or 55 Gallon Drums



Prevent spills from entering your drains. Use Jomac Drain Plugs and Covers found on page 105.



Rieke® FLO-RITE Drum Faucets

Engineered to meet your demand for better chemical resistance. Features instant on/off control for a fast, smooth flow. Fits all standard 3/4" drum openings.



Cubitainer™ Pour Faucets

Strong, durable and easy to use

Fits all standard 38 mm bottle and Cubitainer™ openings. Dispenses fluids safely, without splashing. Made of corrosion-resistant polyethylene. Packaged two faucets per poly bag.

PART #	DESCRIPTION
MIS-PUMFR	FLO-RITE Drum Faucet
MIS-PUMPF	Cubitainer Pour Faucet



HANDY TIP

Justrite Safety Cans are the safe way to store and transfer flammable liquids which have been pumped from larger containers. See pages 106-107 for the complete Justrite line.



Lithco Wash-Up Bottles

A safe and convenient way to store and dispense small quantities of liquid at the work site

Available in 16 ounce or 32 ounce sizes for pin-point liquid dispensing.

- ▶ Ascending and descending scale for tracking solvent usage
- ▶ HMIS label block and space to identify contents

PART #	DESCRIPTION
LIT-WUB16	16 oz. Wash-Up Bottle
LIT-WUB32	32 oz. Wash-Up Bottle

HAND CLEANERS

VIN-DOTCO HAND CLEANERS



Vin-Dotco, the innovator in citrus D-limonene hand cleaners, began their research effort in the early 1970s. They have developed a superior line of safe, environmentally friendly cleaning products to remove even the most difficult inks.



Power Towels™



Multi-purpose hand cleaning system

This unique product combines an industrial strength towel together with a highly effective formula that accelerates removal of tough soilers. The advanced dual action blend quickly penetrates and effortlessly removes the most stubborn inks and grime.

- Contains conditioners to enhance moisture retention of your skin
- Prevents chapping and drying
- Non-scratching towels can be used on many hard-to-clean surfaces
- Quality, convenience and safety in one fantastic package

Really Works® Printer & Pressman Hand Cleaner

Especially formulated with the printer in mind, Really Works is a superior hand cleaner which does "really work." It is extremely effective, yet still leaves your hands feeling clean and soft.

- Available with or without pumice ("non abrasive")
- Biodegradable
- Available in many convenient sizes



4 1/2 lb. CAN WITH 2245 DISPENSER



GALLONS WITH 1200 DISPENSER

PART #	SIZE	DESCRIPTION
VIN-126	16 oz.	Non-abrasive
VIN-131	4 1/2 lb.	Non-abrasive
VIN-22008	1 Gallon	Non-abrasive - Lotion
VIN-125	16 oz.	With Pumice
VIN-130	4 1/2 lb.	With Pumice
VIN-25008	1 Gallon	With Pumice - Lotion
VIN-2245	N/A	Plastic Dispenser for 4 1/2 lb. Cans
VIN-1200	N/A	Plastic Pump for Gallons

PART #	QTY	DESCRIPTION
VIN-51050	50 Towels	Power Towels 9" x 10"
VIN-51100	100 Towels	Power Towels 10 1/4" x 11 3/4"



An extensive line of micrometers and thickness gauges for all purposes can be found on page 28 and 29.



Re-makes caused by dust are costly. Utilize the PCR to eliminate dust on film before platemaking and on ink jet prints before laminating. See page 47.



Scrubs-in-a-Bucket®

*No sink? No soap? No water?
No problem!*

The original and still the best hand cleaner wipe available...no need to settle for cheap imitations. Scrubs-in-a-Bucket combines both a high quality, liquid hand cleaner and a heavy duty, non-scratching abrasive hand-cleaning towel. A special micro-perforation pattern holds the hand cleaner and traps the dirt to prevent it from being re-deposited on the skin. Pleasantly citrus scented and packaged 72 wipes/bucket.

PART #	DESCRIPTION	COUNT
MIS-SIB	Scrubs-in-a-Bucket	72

Lava Heavy-Duty Hand Cleaner Liquid & Towels



It's got clean written all over it

Since 1893, people in all trades and professions have reached for Lava soap when it came time to get really dirty hands clean. Now you have the cleaning power of Lava soap packed into a liquid dispenser or pre-moistened hand cleaner towels. Easily removes grease, ink and adhesives. Built-in moisturizers make Lava gentle to the hands.

PART #	DESCRIPTION
MIS-LAVA32	Lava Liquid – 32 oz.
MIS-LAVAT	Lava Towels – 50 count



GOOP Hand Cleaner

GOOP is a powerful, multi-purpose, cream-type hand cleaner with built-in care for your hands. It contains lanolin to soften and condition your skin. Goop does not contain naphtha, kerosene, ammonia, chlorinated solvents or any other ingredients harmful to your skin. It is biodegradable and non-toxic. Goop is available in the regular unscented formula used for fifty years, or new orange citrus fragrance, with or without pumice. New...now available in pre-moistened towels and a specially formulated Printer's Friend. Available in a variety of sizes.

PART #	SIZE	DESCRIPTION
GOO-14	14 oz.	Regular
GOO-41/2	4½ lb.	Regular
GOO-PUM41/2	4½ lb.	Regular with Pumice
GOO-OR41/2	4½ lb.	Orange Formula
GOO-ORPUM14	14 oz.	Orange with Pumice
GOO-ORPUM41/2	4½ lb.	Orange with Pumice
GOO-ORPUM16	16 oz.	Orange Liquid with Pumice
GOO-ORPUM1/2G	½ Gallon	Orange Liquid with Pumice
GOO-ORPUMG	1 Gallon	Orange Liquid with Pumice
GOO-HCT	90 Towels	10" x 12" Hand Cleaner Towels
GOO-PFG	1 Gallon	Printer's Friend
GOO-DIS	N/A	Dispenser for 4½ lb. Cans



Did you know that PANTONE has an improved formula guide printed on brighter stock with 147 new colors? See page 2.



Webril® Wipes and Pads

Webril Wipes and Pads are made of a unique, high quality material manufactured for the graphics industry. These wipes and pads are highly absorbent, made with 100% pure cotton without fillers, binders, or chemicals.

WEBRIL® WIPES AND PADS					
PART #	DESCRIPTION	SIZE	PACKAGING		
KEN-WEB44	Webril Handi-Pads	4" x 4"	100 pads/pkg.	20 pkg./case	
KEN-WEB88	Webril Wipes	8" x 8"	100 wipes/roll	8 rolls/case	
KEN-WEB48	Webril Litho-Pads	4" x 8"	100 pads/roll	20 rolls/case	
KEN-WEB58	Webril Appli-Pads	5" x 8"	100 pads/roll	8 rolls/case	
KEN-WEB45	Webril Proof-Pads	4" x 5"	100 pads/roll	8 rolls/case	



Verasorb® Absorbent Socks

Verasorb Absorbent Socks absorb ten times their own weight. They are the quick, easy way to clean up leaks and spills around equipment. Available in 38" or 48" lengths, packed 24 socks per case.

VERASORB® SOCKS			
PART #	DESCRIPTION	SIZE	QTY/CASE
KEN-VS38	Verasorb Absorbent Socks	3" x 38"	24
KEN-VS48	Verasorb Absorbent Socks	3" x 48"	24



WEBRIL HAND CLEANERS

Webril Hand Cleaners are formulated expressly for the printing industry. They contain lanolin, aloe vera, jojoba oil and Vitamin E to moisturize skin. Regular use keeps hands clean and conditioned. They contain no petroleum solvents and are pH balanced.

- Webril® Waterless Hand Cleaner
- Webril® Waterless Hand Cleaner with Pumice
- Webril® Natural Citrus Hand Cleaner
- Webril® Hand Cleaner Wipes **NEW**



PART #	SIZE	DESCRIPTION	QTY/CASE
KEN-WEB41/2	4½ lb.	Webril Waterless Hand Cleaner	6
KEN-WEBGRITG	1 Gallon	Webril Waterless Hand Cleaner With Pumice	4
KEN-WEBKIT41/2	4½ lb.	Webril Natural Citrus Hand Cleaner With Pumice	6
KEN-WEBKITG	1 Gallon	Webril Natural Citrus Hand Cleaner	4
KEN-WEBKIT15	15 oz.	Webril Natural Citrus Hand Cleaner	12
KEN-WEBHCW	Tub	Webril Hand Cleaner Wipes – 70 count	6
KEN-41/2DIS	—	Dispenser for 4½ lb. Cans	1
KEN-CITRAK	—	Rack for Gallons	1



Are your customers complaining about scuffmarks caused by the transfer cylinder? Try NEW Vintage Quack Anti-Marking Nets for mark-free transfers...and satisfied customers. See page 90.

Veratec® Cheesecloth

Soft, absorbent, and scratch-proof, Veratec Cheesecloth is the ideal material for cleaning glass or applying a uniform, thin film of gum to an offset plate. Many printers use cheesecloth as a reinforcement when making pads.



VERATEC® CHEESECLOTH			
PART #	DESCRIPTION	SIZE	PACKAGING
Economy-Cut Rolls			
KEN-CUR4ORL	Grade 40	30" x 36" Four Ply	120 pieces per roll
KEN-CUR5ORL	Grade 50	30" x 36" Four Ply	120 pieces per roll
KEN-CURRAK	Rack for Rolls		1 per case
Handi-Fold Bolts			
KEN-CUR1OBLT	Grade 10	80 Yards x 36"	10 bolts per case
KEN-CUR4OBLT	Grade 40	70 Yards x 36"	10 bolts per case
KEN-CUR5OBLT	Grade 50	70 Yards x 36"	10 bolts per case

Photex® Scanner and Screen Wipes

Leaves critical surfaces lint and static free

This disposable non-woven wipe is formulated for use on color scanners and display screens. Photex Scanner and Screen Wipes are designed to encapsulate dust without leaving a residue.



PHOTEX® SCANNER AND SCREEN WIPES	
PART #	DESCRIPTION/PACKAGING
KEN-PHOTEX	Scanner Wipes 9" x 13" 100 wipes/package 4 packages/case
KEN-PHOTEXS	Screen Wipes 7" x 13" 25 wipes/package 12 packages/case

Nubtex® Shop Cloths

Nubtex Shop Cloths are a new approach to pressroom cleaning. They combine the feel and durability of cloth towels with the ease and convenience of disposable wipes. Available in four sizes, as well as a convenient pop-up box.

Snowtex™ Cloth Wipes

Made of 100% rayon with no chemical binders, extra absorbent Snowtex™ Cloth Wipes are ideal for all pre-press and pressroom wiping needs. Soft, strong, and quick drying. Available in four sizes.

NUBTEX® SHOP CLOTHS AND SNOWTEX CLOTH WIPES				
PART #	DESCRIPTION	SIZE	PACKAGING	
KEN-NT313	Nubtex	13" x 13"	25 wipes/bundle	15 bundles/case
KEN-NT317	Nubtex	13" x 17"	25 wipes/bundle	15 bundles/case
KEN-NT617	Nubtex	16" x 17"	25 wipes/bundle	15 bundles/case
KEN-NT216R	Nubtex	12 ³ / ₁₆ " x 15 ³ / ₄ "	400 wipe/roll	2 rolls/case
KEN-NTP	Nubtex NEW	12" x 17"	150 wipes	Pop-up box
KEN-STQF80	Snowtex	13" x 13"	25 wipes/bundle	15 bundles/case
KEN-STQF81	Snowtex	13" x 17"	25 wipes/bundle	15 bundles/case
KEN-STQF82	Snowtex	16" x 17"	25 wipes/bundle	15 bundles/case
KEN-STPR96	Snowtex	12 ³ / ₁₆ " x 17 ⁵ / ₁₆ "	400 wipes/roll	2 rolls/case
KEN-NSTFR	Floor Rack for Rolls		1/case	
KEN-NSTWR	Wall Rack for Rolls		1/case	

LOOK FOR THESE OTHER FINE PRODUCTS FROM BBA NONWOVENS

 *Hyton®, Red-1®, Red Runner™ Page 76*

Quack®/Vintage Quack™ Anti-marking Nets Page 90

Web-Lock Splicing Tapes Page 119



MISCELLANEOUS

TORK WIPES

TORK® WIPES FROM SCA HYGIENE PAPER

Check out this comprehensive line of wiping products designed with all aspects of the graphic arts industry in mind. The various TORK wipes are available in rolls, dispenser boxes or the new Top-Pak® to fit the Top-Holder® Dispensers.



M-Tork Plus Pre-Press Wipes

These pure cellulose wipes are ideal for pre-press wiping where lint-free and streak-free wiping of film, plates and glass is essential. Standard grade from recycled material also available.

E-Tork Soft

The perfect wipe for sensitive applications

This high-quality wipe combines softness, strength, superior absorbency and durability. Holds and releases more solvents and liquids. Perfect for screen printers.

Lint-free and streak-free. (Replaces P-Tork)



A-Tork General Purpose Wipes

A-Tork is water, solvent and detergent resistant and very strong when wet. Excellent for wiping down machinery, mopping up floor spills and general cleaning.

- Made from 100% pure cellulose
- Super absorbent



Other Tork brand wipes are also available.

Tork Multi

A totally new and versatile medium-duty wiper

Tork Multi is designed to replace the mixed-color textile rags that are used in many shops. Unlike rags that come in many sizes, textures and degrees of cleanliness, Tork Multi are all uniform size, identical composition and are never contaminated by a prior user.

- Highly absorbent, soft and strong
- Excellent for wiping up, cleaning up and polishing
- Made from non-woven cellulose and synthetic fiber



E-Tork Strong - Heavy Duty Wipes

The perfect shop rag replacement

Tough enough to resist tearing even when used with solvents or water-based chemicals. Soft, absorbent and will not scratch.



Tork Dispensers

The convenient way to dispense wipes. M-Box and Maxi-Box are wall-mounted units which lock to prevent waste. Top-Holder is wall mounted and allows Top-Paks to be dispensed from either top or bottom.



M-BOX



MAX-BOX



TOP-HOLDER

PART #	PACKAGING	PRODUCT	DESCRIPTION
MIS-M199178	Top-Pak	Tork Multi	15" x 16.8" 1-ply wipes, 150 wipes/cartridge
MIS-M199171	Pro-Box	Tork Multi	15" x 16.8" 1-ply wipes, 300 wipes/box
MIS-M101234	Rolls	M-Tork Plus	9" x 11.8" 2-ply wipes, 600 wipes/roll
MIS-M120134	Rolls	M-Tork Std.	9" x 11.8" 2-ply wipes, 600 wipes/roll
MIS-M121201	Rolls	M-Tork Std.	9" x 11.8" 1-ply wipes, 1000 wipes/roll
MIS-M196137	Maxi Rolls	E-Tork Strong	12.6" x 15.7" 1-ply, 338 wipes/roll
MIS-M196173	Top-Pak Mini	E-Tork Strong	12.7" x 15" 1-ply, 90 wipes/cartridge
MIS-M196175	Flexi-Box	E-Tork Strong	12.7" x 15" 1-ply, 340 wipes/box
MIS-M196176	Top-Pak	E-Tork Strong	12.7" x 15" 1-ply, 190 wipes/cartridge
MIS-M550137	Maxi Rolls	E-Tork Soft	12.6" x 15.7" 2-ply wipes, 375 wipes/roll
MIS-M130251	Rolls	A-Tork	9" x 15.7" 2-ply wipes, 325 wipes/roll
MIS-M130273	Top-Pak Mini	A-Tork	12.7" x 15" 2-ply wipes, 110 wipes/cartridge
MIS-M202071	M-Box	Dispenser	For Standard Rolls
MIS-M203051	Maxi-Box	Dispenser	For Maxi Rolls
MIS-M207300	Top-Holder	Dispenser	For Top-Paks and Top-Pak Minis



Squeegees

The perfect tool for graphic arts darkrooms and platerooms

These squeegees have a soft rubber blade that is locked into an unbreakable plastic handle.

- Acid and corrosion resistant
- Cannot scratch emulsions
- Durable and long-lasting

PART #	DESCRIPTION
MIS-SQ9	9" Squeegee
MIS-SQ14	14" Squeegee

Cotton Tipped Applicators

Here is an economical and indispensable tool for general pre-press and pressroom usage. Use in confined, hard-to-reach areas for applying small quantities of chemicals or for close, detail work. Applicators have pure cotton tip on a 6" wooden handle.



PART #	DESCRIPTION
MIS-TIPS	Package of 100



Cotton Tipped Applicators moistened with Burnishine Gold Miracle are great for removing cut marks from photo direct plates.

Lithco Tack Cloth

Eliminates paper dust from freshly trimmed lifts of paper

The Lithco Tack Cloth may just become the paper cutter's best accessory. Use it to wipe the edges on freshly trimmed paper. Each wipe individually bagged.

- Helps eliminate hickies in printing
- Helps eliminate air bubbles in laminating

Natural Sea Wool Sponges

Harvested direct from the bottom of the ocean, these super absorbent sponges are hand picked, sorted for size and quality, then pre-washed to protect plates and blankets from foreign particles. We recommend that you wash them again when ready for use to remove any residual foreign matter.



Cellulose Sponges

For photographic use, wiping film and litho plates, and general use in pre-press and pressroom. Available in your choice of coarse or fine pore, regular or compressed.



PART #	DESCRIPTION	PORE	SIZE
SPO-SEA	Natural Sea Wool Sponge	—	7½" - 8"
SPO-6A	Cellulose Sponge	Coarse	6" x 3½" x 1"
SPO-8A	Cellulose Sponge	Coarse	5¾" x 4" x 1⅜"
SPO-10A	Cellulose Sponge	Coarse	7" x 4⅜" x 2"
SPO-6AF	Cellulose Sponge	Fine	6" x 3½" x 1"
SPO-8AF	Cellulose Sponge	Fine	5¾" x 4" x 1⅜"
SPO-10AF	Cellulose Sponge	Fine	7" x 4⅜" x 2"
SPO-COM	Compressed Sponge	Fine	5¾" x 3¾" x ⅜" Expanded size: 5¾" x 3¾" x 1¼"
SPO-COMC	Compressed Sponge	Coarse	4" x 1¼" x ⅜" Expanded size: 4" x 2¾" x 1¼"

Kimberly-Clark Wipes



A selection of wiping products to meet the wide variety of needs throughout the plant

- **Kimwipes® EX-L:** This popular prepress wiper is soft, gentle, absorbent and low-lint.
- **Kaydry® EX-L:** Unique combination of low-lint tissue, softness and multiply absorbency that's perfect for a multitude of delicate tasks.
- **Kimtex®:** Reusable, heavy-duty shop towels for use with oils and solvents.



PART #	SIZE	PLIES	DESCRIPTION	WIPES/PKG.	PKG./CASE
MIS-KIMWIPES	15" x 17"	1	Kimwipes EX-L #34256	140	15
MIS-KDRYS	15" x 17"	2	Kaydry EX-L #34721	90	15
MIS-KIMTEX	12" x 14"	1	Kimtex #33560	50	10
MIS-KIMTEXS	9¾" x 16¾"	1	Kimtex #33570	100	5

- Removes paper dust from cutter bed, back gauge and control panels
- Use as a general-purpose, bindery dusting-wipe
- Removes spray powder from folders and collators

PART #	DESCRIPTION
LIT-TC	Tack Cloth 18" x 36"



PROCAM FILTERS & WATER PANELS

Procam Filter Cartridges

The right filter for every application



Procam Controls specializes in filter cartridges for the photographic and graphic arts industries. Filter cartridges are available for water panels and recirculators, plate processors – aqueous and solvent, film and imagesetting processors and color proofing processors. With Procam Filters, you always receive:

- Consistent quality
- Specifications that meet or exceed OEM
- Best value for the price



PART #	MICRON	LENGTH	CORE	DESCRIPTION
PRO-PCP0597	5	9 ³ / ₄ "	Poly	Wound Polypropylene Filter
PRO-PCP0598	5	9 ⁷ / ₈ "	Poly	Wound Polypropylene Filter
PRO-PCP1098	10	9 ⁷ / ₈ "	Poly	Wound Polypropylene Filter
PRO-PCP2597	25	9 ³ / ₄ "	Poly	Wound Polypropylene Filter
PRO-PCP2597D	25	9 ³ / ₄ "	1.22 id	Wound Polypropylene Filter
PRO-PCP2598	25	9 ⁷ / ₈ "	Poly	Wound Polypropylene Filter
PRO-PCP25125	25	12 ¹ / ₂ "	Poly	Wound Polypropylene Filter
PRO-PCP2520	25	20"	Poly	Wound Polypropylene Filter
PRO-PCP7598	75	9 ⁷ / ₈ "	Poly	Wound Polypropylene Filter
PRO-PCC1098	10	9 ⁷ / ₈ "	Poly	Wound Cotton Filter
PRO-PCC2010	20	10"	Poly	Wound Cotton Filter
PRO-PCC3010	30	10"	Poly	Wound Cotton Filter
PRO-PCG7598	75	9 ⁷ / ₈ "	Poly	Wound Cotton Filter
PRO-PCG0198	1	9 ⁷ / ₈ "	N/A	Melt-Blown Polypropylene Filter
PRO-PCG0548	5	4 ⁷ / ₈ "	N/A	Melt-Blown Polypropylene Filter
PRO-PCG0598	5	9 ⁷ / ₈ "	N/A	Melt-Blown Polypropylene Filter
PRO-PCG0520	5	20"	N/A	Melt-Blown Polypropylene Filter
PRO-PCG1098	10	9 ⁷ / ₈ "	N/A	Melt-Blown Polypropylene Filter
PRO-PCG2010	20	10"	N/A	Melt-Blown Polypropylene Filter
PRO-C35EP	10	9 ³ / ₄ "	Poly	Resin-Bonded Fiberglass
PRO-C5EP	25	9 ³ / ₄ "	Poly	Resin-Bonded Fiberglass
PRO-PCM0597	5	9 ³ / ₄ "	Poly	Pleated Cellulose
PRO-PCM3048	30	4 ⁷ / ₈ "	Poly	Pleated Polyester
PRO-PCB0110 ¹	1	10"	N/A	Hi-Efficiency Melt-Blown Polyolefin ¹
PRO-PCB0510	5	10"	N/A	Hi-Efficiency Melt-Blown Polyolefin
PRO-PCFKB20	1	20"	N/A	FKB20 Bag-Style Filter

Note: All Procam Filter Cartridges are available. Replacement filter housings are available. Please inquire for items not listed. ¹ Fount-N-Kleer replacement

Water Treatment Wall Packs



Economical method of softening or deionizing water

These compact units are designed for the user who requires less than 50 gallons per week of purified water to mix chemistry. Ideal for CTP and Matchprint III users.



WS220

PART #	DESCRIPTION
PRO-WS220	Water Softener Wall Pack – Cartridge-style Compact Water Conditioner
PRO-DI20BB3	Deionization Wall Pack – Cartridge-style Compact Water DI System

Water Filter Housing Kits



Complete with filter, wrench, bracket and 3/4" x 1/2" hex bushings



PART #	DESCRIPTION
PRO-10BKIT	Blue Filter Housing Kit
PRO-10HKIT	Hot Water Filter Housing Kit
PRO-10OS	O-Rings, Set of 6 for #10, #12 and #20 Filter Housings

Procam Water Control Panels

A variety of configurations available to meet your specific requirements



- Automatic thermostatic mixing valve ±1/2°F
- 3" dial, dual-scale adjustable temperature gauge
- Chrome plated brass fittings and valves
- Fully assembled and pressure tested



MODEL 650S

PART #	MODEL	OUTLETS	FLOW METER	VACUUM BREAKER	FILTERS	DESCRIPTION
PRO-500VB	500VB	1	No	Yes	1	Economy Water Panel
PRO-650S	650S	2	No	Yes	1	Standard Water Panel
PRO-670S	670S	2	Yes	Yes	1	Standard Water Panel
PRO-750S	750S	2	Yes	Yes	2	Deluxe Water Panel

All Procam Water Control Panels are available. Please inquire for models not listed.

COMFORT & CONVENIENCE

Shop Equipment Stands, Utility Carts & Shelves



Designed to hold an amazing 800 lb. per shelf

These heavy-duty stands, shelves and carts are ideal for storing and moving cut sheets of paper and portable equipment such as padding presses, folders and scales. They assemble in minutes with just a hex wrench (included).

- Made of aluminum
- Equipment stand has two shelves, available with or without casters
- Carts feature two swivel and two locking casters, adjustable height handle
- Shelving unit has four adjustable shelves



PART #	SIZE (W x H x L)	DESCRIPTION
EQP-PVES203036	20" x 30" x 36"	Equipment Stand
EQP-PVES243036	24" x 30" x 36"	Equipment Stand
EQP-PVES203036C	20" x 36" x 36"	Equipment Stand w/Casters
EQP-PVES243036C	24" x 36" x 36"	Equipment Stand w/Casters
EQP-PVUC203736	20" x 37" x 36"	Utility Cart – Small
EQP-PVUC243736	24" x 37" x 36"	Utility Cart – Large
EQP-PVSU2060364	20" x 60" x 36"	Shelving Unit w/Four Shelves
EQP-PVSU2060484	20" x 60" x 48"	Shelving Unit w/Four Shelves

NOTE: Other configurations are available, inquire.

Barefoot® Ergonomic Flooring System

More comfort than you can imagine

Now you can have all the ergonomic benefits of high-tech polyurethane for a fraction of the cost, with a product that is also environmentally responsible.

- Patented tri-radial supports perform like individual springs under your feet
- Provides cushion and a remarkably high degree of support
- All module sides interlock and are beveled for **your safety**
- Unique design allows air to circulate under the mat to prevent moisture build-up which reduces or eliminates mold, mildew and musty odors
- The 45° module is perfect for fitting around counters and equipment, and is scored to adapt to both mat sizes
- Drain-through mats feature surface holes every third cushion



PART #	SIZE	DESCRIPTION
MIS-BF23	2 ft. x 3 ft.	Barefoot Module
MIS-BF34	3 ft. x 4 ft.	Barefoot Module
MIS-BF2345	Fits Both	Barefoot Module – 45°
MIS-BFxy	Custom*	Barefoot Module
MIS-BFDT23	2 ft. x 3 ft.	Drain-through Barefoot Module
MIS-BFDT34	3 ft. x 4 ft.	Drain-through Barefoot Module

THE ONE THAT WORKS – Printers' Air Purifier



The only air filter specifically designed for the pressroom

Created for the pressroom, it is designed to clear the air of chemical fumes, paper dust, smoke, spray powder and other odors associated with print shops. Unlike electronic particle collectors, the One That Works filters the air through six pounds of activated charcoal that attracts fumes and odors. A second, washable dust filter traps paper lint and spray powder.

- Two-speed operation – 400/600 cubic feet per minute of air
- Completely portable
- Economical to operate – costs about the same as a 150 watt light bulb
- Low maintenance – change activated charcoal filter every six months
- Washable, replaceable polyurethane foam dust filter traps particles as small as 1.0 micron
- Services a room up to 1,000 square feet – use multiple units evenly spaced for larger facilities
- One year warranty



PART #	DESCRIPTION
EQP-OTW	The One That Works Printers' Air Purifier
EQP-OTWAC6	Activated charcoal – 6 lb.
EQP-OTWWDF	Washable Dust Filter

*Barefoot Ergonomic Flooring System Mats are available in custom sizes up to 8' x 60' and are cut to within an inch of specification. Contact your Dealer or Lithco Customer Service for custom sizes.

MISCELLANEOUS

SHRINK FILM & JOB JACKETS

SHRINK FILM

► PVC Shrink Film

A balance oriented film with equal shrinkage in both machine and transverse directions



Suitable for most types of industrial packaging and can be used on automatic, semi-automatic and manual machinery.

► Polyolefin (PO) Shrink Film

User-friendly, strong, cross-linked shrink film

Suitable for a wide range of packaging applications, the innovative crosslink manufacturing process provides strong, durable seals and excellent shrinkage.

► Polyolefin Anti-Static Shrink Film

High performance dissipative shrink film for critical applications

For only pennies more per application, prevent dangerous static electricity discharges from damaging sensitive components. Ensure compliance with ESD protocols.

PART #	GAUGE	WIDTH	LENGTH
PVC Centerfold Shrink Film*			
MIS-PVC1075500	75	10"	500'
MIS-PVC1275500	75	12"	500'
MIS-PVC1475500	75	14"	500'
MIS-PVC1675500	75	16"	500'
MIS-PVC1875500	75	18"	500'
MIS-PVC1075	75	10"	2000'
MIS-PVC1275	75	12"	2000'
MIS-PVC1475	75	14"	2000'
MIS-PVC1675	75	16"	2000'
MIS-PVC1875	75	18"	2000'
MIS-PVC16100	100	16"	1500'
MIS-PVC18100	100	18"	1500'
MIS-PVC20100	100	20"	1500'
PO Centerfold Shrink Film*			
MIS-PO1060	60	10"	4350'
MIS-PO1260	60	12"	4350'
MIS-PO1460	60	14"	4350'
MIS-PO1660	60	16"	4350'
MIS-PO1860	60	18"	4350'
MIS-PO1075	75	10"	3500'
MIS-PO1275	75	12"	3500'
MIS-PO1475	75	14"	3500'
MIS-PO1675	75	16"	3500'
MIS-PO1875	75	18"	3500'
MIS-PO12100	100	12"	2650'
MIS-PO14100	100	14"	2650'
MIS-PO16100	100	16"	2650'
MIS-PO18100	100	18"	2650'
PO Anti-Static Centerfold Shrink Film			
MIS-POAS10100	100	10"	2620'
MIS-POAS12100	100	12"	2620'
MIS-POAS14100	100	14"	2620'
MIS-POAS16100	100	16"	2620'
MIS-POAS18100	100	18"	2620'

*Other sizes and gauges available.

JOB JACKETS

Store and protect your job materials

► Job Jacket & Storage Envelopes

- Heavy-duty, 28# kraft envelopes
- Excellent for storage of job materials and delivery of comps
- Flap on short side
- Flaps are ungummed for repeated use
- Economical 25 envelopes/box



► Sewn Clear Plastic Job Jackets

- Heavy-duty, 10 mil clear plastic jacket allows contents to be easily seen
- Industrial nylon, reinforced, stitched seams
- Grommet for hanging
- Open on short side



PART #	SIZE	DESCRIPTION
MIS-JJE121/2181/2	12½" x 18½"	Envelopes
MIS-JJE1520	15" x 20"	Envelopes
MIS-JJE1722	17" x 22"	Envelopes
MIS-JJE2227	22" x 27"	Envelopes
MIS-JJS9111/2S	9" x 11½"	Sewn Clear Plastic
MIS-JJS9141/2S	9" x 14½"	Sewn Clear Plastic
MIS-JJS111/2171/2S	11½" x 17½"	Sewn Clear Plastic
MIS-JJS1420S	14" x 20"	Sewn Clear Plastic

Job Jackets with the opening on the long side are available as a special order. Please inquire.

Customize your Job Jackets with 3L Media Storage Pockets

Never wonder if the media is with the job again

Attach one or more of these media storage pockets to your job jacket. Permanent adhesive bonds to paper, vinyl or polypropylene.

- Special adhesive backed pockets hold CDs, Zip Disks, Floppy Disks or Job Tickets
- Flap secures media in pocket



See pages 100 – 101 for a complete listing and ordering information for 3L Media Storage Pockets

TAPES & DISPENSERS

PART #	STYLE	ROLL WIDTH
3M-6161/8	#616	1/8"
3M-6161/4	#616	1/4"
3M-6163/8	#616	3/8"
3M-6161/2	#616	1/2"
3M-6163/4	#616	3/4"
3M-6161	#616	1"
3M-2561/4	#256	1/4"
3M-2561/2	#256	1/2"
3M-2563/4	#256	3/4"
3M-2561	#256	1"
3M-25611/2	#256	1 1/2"
3M-2021/2	#202	1/2"
3M-2023/4	#202	3/4"
3M-2021	#202	1"
3M-20211/2	#202	1 1/2"
3M-6003/8	#600	3/8"
3M-6001/2	#600	1/2"
3M-6003/4	#600	3/4"
3M-6001	#600	1"
3M-8101/2	#810	1/2"
3M-8103/4	#810	3/4"
3M-4651/2	#465	1/2"
3M-4651	#465	1"
3M-46511/2	#465	1 1/2"
3M-4652	#465	2"
3M-2323/4	#232	3/4"
3M-2321	#232	1"
3M-2353/4	#235	3/4"
3M-2351	#235	1"
3M-6811/2	#681	1/2"
3M-8501/2	#850 - Silver	1/2"
3M-8501/2CLR	#850 - Clear	1/2"
3M-8981	#898	1"



3M TAPES

- Red Lithographer's Tape #616 - 72 yard rolls
- White Flatback Paper Tape #256 - 60 yard rolls
- Paper Masking Tape #202 - 60 yard rolls
- Transparent Film Tape #600 - 72 yard rolls
- Magic Mending Tape #810 - 72 yard rolls
- Two-Sided Adhesive Transfer Tape #465 - 60 yard rolls
- Hi-Performance Masking Tape #232 - 60 yard rolls
- Black Tape #235 - 60 yard rolls
- Transparent Film Tape #681 - 72 yard rolls
- Poly Tape #850 - Silver, Clear - 72 yard rolls
- High Performance Filament Tape #898 - 60 yard rolls



3M Tape Dispensers

The perfect companion for 3M Tapes

These high impact plastic dispensers are designed for 3M tapes with 3" cores. Models P52W and P56W feature weighted bottoms. Replacement corrugated and coin edge blades available.



Web-Lock® Splicing Tapes

Specifically designed for maximum shear strength, the high tack adhesive of Web-Lock Splicing Tapes delivers superior performance. Offered in both standard and repulpable versions.

PART #	DESCRIPTION	CAPACITY
3M-C23	Heavy Duty Dispenser	One roll up to 1" wide
3M-C22	Heavy Duty Dispenser	One roll up to 2" wide or two 1" rolls
3M-P52W	Multi-roll Dispenser	Up to four 1/2" rolls, or other combinations
3M-P56W	Multi-roll Dispenser	Up to eight 1/2" rolls, or other combinations

PART #	DESCRIPTION
3M-C22CORR	C22 Corrugated Blade
3M-P52COIN	P52 Coin Blade
3M-P52CORR	P52 Corrugated Blade
3M-P56COIN	P56 Coin Blade
3M-P56CORR	P56 Corrugated Blade



For a complete selection of scanning supplies see page 42.

PART #	STYLE	DESCRIPTION	TACK	COLOR	LENGTH	WIDTHS (IN.)
KEN-WLTN25x	TN-25	Non-repulpable Transfer Tape	High	Pink	60 yds.	1/2, 3/4, 1, 1 1/2, 2
KEN-WLDN32x	DN-32	Non-repulpable Double Faced Tape	High	Natural	60 yds.	1/2, 3/4, 1, 1 1/2, 2
KEN-WLDN31x	DN-31	Non-repulpable Double Faced Tape	High	Red	60 yds.	1/2, 3/4, 1, 1 1/2, 2
KEN-WLDR70x	DR-70	Repulpable Tape	Very High	Green	36 yds.	1/2, 3/4
KEN-WLDR70x	DR-70	Repulpable Tape	High	Green	72 yds.	1, 1 1/2, 2

*Replace "x" with required width such as KENWLDN3211/2.

INDEX

3L Pockets 100-101
 3M Sprays & Tapes 33, 119

A

Air Purifiers 46, 117
 Alcohol Replacement 60, 63-64
 Alcohol Testers 89
 Algae Control 46
Alignmate 30
 Angle and Line Determiners 27-28
 Anti-Marking Nets 90
 Anti-Marking Sheets 87
 Anti-Static Brushes 48
 Anti-Static Gloves & Cloth 48
 Anti-Static Spray 63, 66, 67
 Aprons 108
 Automatic Blanket Cleaning
 Cloth 87
Autotype 55

B

Barefoot Mats 117
Base-Line Products 37, 53, 56-57, 74-75
BBA Nonwovens 76, 112-113, 119
Beta Industries 13-15
 Bindery Equipment 92-95, 98, 102-103
 Blades 18, 20-23
 Blanket and Roller Washes 58, 62
 Blanket Fix 59, 63, 80
 Blankets 68-69
 Brayer 32
Burnishine Products 60-61
 Business Card Pockets 100
 Business Card Slitters 92

C

Carbon Arcs 55
Card-It 99
 Cat's Whiskers 85
 Chain Cleaner/Lubricant 65
 Cheesecloth 113
Chemgon 43
Chemview 65
 Chemical Storage Tanks 46
 China Markers 52
 Chrome Cylinder Cleaner 61
 Clean-Up Sheets 71, 75
 Color Bars 15
 Color Management Software 6, 36, 37
 Color Guides 2-6, 30, 80
 Color Viewing Lights 34
ColorBlind 36
 Conductivity Meters 83, 84
 Contact Boards 55
 Corner Cutter 95
 Corner Pockets 100
Correct-A-Neg™ Opaque Pens 52
Correct-A-Plate™ Pens 88
 Correction Pens 52, 75, 88
 Cotton Gloves 47
 Cotton Pads & Wipes 112
 Cotton Tipped Applicators 115
 Counter, electronic 93
C-Thru Rulers 27
 Cutting Sticks 97
 Cyber-Fabric 42

D

Dampening Covers & Supplies 74, 76
 Darkroom Supplies &
 Accessories 44-48
Day In'1 Blankets 69
 DCS Color Books 6
 Deglazers 58, 61, 63, 66, 80
 Densitometers 14-17
 Developers, Film & Plate 44, 64
 Developing Pads 54
 Developing Trays 45
 Digital Duplicator
 Masters & Inks 41
Digital Media Training 35
 Document Pockets 100
 Drain Covers & Plugs 105
 Drill Bits & Accessories 96-97
 Drill Ease 96
 Duotone Guide 5
DuraPaper 88
 Durometer 70
 Dust Bunny 49
 Dust Controller 49
 Dust Masks 108
Dust-Off 42, 67

E

E•A•R® Plugs 108
Edwal Chemistry 43
Encapsulate Sleeves 45
 Equipment Stands 117
 EZ Skid 87

F

Falcon Safety Products 42, 67
 Film Cleaners 58, 63, 66
 Film, Camera 44
 Film Scribes 23
 Filters 90, 116
 Fixer 44
 Floor Mats 117
 Foam Board & Cutters 19
 Folders, Air & Friction 92
 Folding Bones 99
 Formula Guides, PANTONE 2, 80
 Fountain liners 86
Fountain "Stew" 59
 Fountain Bottles & Valves 85
 Fountain Solution Filters 90, 91
 Fountain Solutions 59, 60, 62, 64, 80

G

Gaebel, Arthur H. 24-25
Gator Spill Containment 107
 Glass Cleaners 58, 63, 66-67
 Gloss Meters 17
 Gloves 47-48, 104-105
Goop Hand Cleaners 111
 Graduated Cylinders 44
 Gray Scales 43, 55
 Gum Arabic 14" Be 59, 63

H

H.S. Boyd 72-73, 121
 Hand Cleaners 60, 110-112
 Hearing Protectors 108
 Heidelberg Supplies 86-87
 Hexachrome® 2, 3, 37
 Hole Strengtheners 51
 Hones 89

I

IdentaFONT 35
Ihara Densitometers 16, 17
Impress 49
 Ink Anti-Skinning Sprays 63, 66, 67
Ink Eaters™ 91
 Ink Jet Media & Inks 38-40
 Ink Knives 77
 Inks 40-41, 78-79
 Ionix Static Eliminator 91
 Isopropyl Alcohol 58, 63

J

J's Plate Kleen 64
James Burn In'1 55, 103
 Job Jackets 118
 Jogger Blocks 97
 Joggers 93
Jomac® Brand 74, 104-105
Justrite Safety Cans 106-107

K

Kami Scanner Products 42
Kimberly-Clark Wipes 115
Kimoto Opaque Pens 52
Kinetronics 48
 Knives 18-22

L

Lamson Ink Knives 77
 Laser Film 39
 Laser Plates 37, 39
Lava Hand Cleaners 111
LectroStik Waxers & Wax 33
 Light Boxes 34
 Line Gauges 24
 Linen Covering 76
 Linen Testers 8
 Litho Needles 23
Litho-Perf, Score, etc. 72-73
LithoProof Proofing Paper 54
 Lubricants 65, 66

M

Magnetic Cutter Pads 97
 Magnifiers 7-13
Mark-Tex Pens 53, 88
Martin Yale 31, 92-93

Masking Films 54, 56
 Masking Sheets 56
 Media Storage Pockets 100
 Metering Roller Cleaner 57-58, 63
 Micrometers 28-29
 Microscopes 11-13
Modern Solutions 42, 49
Myron L 84

N

Nacco Chemical Products 44, 64
 Needles, Sewing 76
Noglare Monitor Hoods 42
 Non-Offset Spray Powder 59, 63
 Non-Repo Pens & Pencils 53
 Nubtex Shop Towels 113

O

Oakton Instruments 82-83
Ohaus Scales 81
Olfa Cutters & Blades 20-22
 Opaque, Brushes & Pens 52-53
 Optics 7-13
 Orange Vinyl Mask 56

P

Packing Gauges, **Trupak** 70
 Padding Presses & Tools 98
 Padding Compounds 98
PANTONE® 2-5, 34, 37, 81-81
 Paper Cutter 93
 Paper Damp 76
 Paper Drill 93
 Paper pH Test Pen 88
 Paper Trimmers 31
 Paraffin Oil 42
 Paragons 12
 Paramags 12
 Particulate Cleaner Roller 47
 Paste-up Kit 23
PDI Binding Systems 102
Peak Magnifiers 10-11
 Pens, Opaque, Plate, etc. 52-53, 75, 88
 Perf Print Plus 121
 pH Meters & Test Strips 82, 84, 89
 Pholex Wipes 113
Pickerbook Publishing 5
 Pile Separators 71
 Pinbars 50
 Plastic Cutting Sticks 97
 Plate Cleaners 57, 61, 63, 64
 Plate Developing Pads 54
PlateStrips 55
Plexus Pacific Industries 28, 70, 87
Pocket Pal 34
Poliwand™ 49
 Polyester Stripping Films 56
Polygenex Gloves 47
Porta-Trace Light Boxes 34
Premium Blue Blankets 68
Prepress Innovations 6
 Press Packing Sheets 71
 Print Tongs 44
PRINTMAtE 28
Procam 46, 90, 116
 Processor Cleaner Sheets 43
 Proofing Papers 39, 54
 Proportion Wheels 30
 Pumice Powder 59
 Pumps 109
 Punches, Plate 55
 Punches, Register 50

Q

Quack Anti-Marking Neis 90
QIP Glossmeters 17

R

Ramsey Film Scribes 23
Rapid Staplers & Staples 94
 Razor Blades 23
Really Works Hand Cleaners 110
 Register Pins, Tabs, etc. 50, 51
Riegel PressPak 71
Rieke Metal Pumps 109
Roller Guard 91
 Roller Lube 63, 64
Rosos Fountain Solutions 64
Rotatrim Rotary Cutters 31
 Rubber Cement & Thinner 66
 Rulers 24-28
Russel Ink Knives 77

S

Safety Goggles 108
 Safety Rulers 26
 Scales 30, 81, 102
 Scissors 20
 Score II Perf & Score Board 95
 "Scotch" Hones 89
 Screen Finder Guide 27-28
Scrubs-in-a-Bucket 111
 Self-Healing Cutting Mats 19, 22
 Self-Laminating Pouches 101
Sharpie Pens 53
 Sheet Separators 85
 Shelving Units 117
 Shrink Film 118
Shur-Fit Vinyl Gloves 104
 Silicone Spray 63, 66, 67
 Silverchem Activator
 & Stabilizer 64
 Skrebba Staplers & Staples 95
 SKS Loupes 12
 Slipon Tubes 74
 Snake Slips 89
Spectromac 17
 Spill Containment 107, 108
 Spin-A-Roll 90
 Splicing Tapes 119
 Sponges 115
Sprayway Aerosols 66
 Squeegees 115
 StackWagon 92
Stanley Bostitch 94
 Staplers & Staples 94-95
Staticmaster Brushes 48
 StikkiStuff 33
 Stitching Wire 94
Stouffer Gray Scales 43, 55
 Suckers 85

T

Tabber 93
 Tack Cloth 115
 Tack Reducer 80
 Tacky Finger 99
 Tape & Dispensers 119
 Temperature Testers 82-84
Test Strip Software 37
 The Collector 38
 The One That Works
 Air Purifier 117
 Thread, Sewing 76
 Tinsel 91
Tork Wipes & Dispensers 114
 Training 35
 Tray & Processor Cleaners 43
 Triangles 26
 Trimmers 31
Trumph Duplicator
 Registration System 50
Trupak Packing Gauges 70
 TSquares 26
 Type Size Finders 8, 27-28

U

Uhu® Glue Sticks 32
Ulano 55
 Unicoil Binding Elements 103
 Utility Carts 117

V

Van Son 40-41, 78-80
Varn Products 62-63
 Verasorbs 112
 Vinyl Book Covers 99

W

Wash-Up Bottles 107, 109
 Water Filter Housing Kits 116
 Water Hardness Test Strips 89
 Water Panels 116
 Water Treatment Wall Packs 116
 Wax & Waxers 32, 33
WD-40 Lubricant 65
 Web Roll Strippers 90
 Splicing Tapes 119
 Webroll Wipes & Pads 112
Weldon Roberts 289R Hones 89
 Wipes & Pads 49, 112-115
 Wire-O Binding Elements 103

XYZ

X-Acto 18-19, 31
Zig Opaque Pens 52

PPP-System

Turn ANY printing press into an in-line finishing system

Accept jobs that you used to turn down and complete jobs in house by using Perf Print Plus®. This revolutionary in-line system perforates, die-cuts, slits and scores in one operation on an offset press. An additional benefit is spot printing and spot varnishing capabilities. The development of the PPP System began in 1994 in Europe. Since then, printers throughout Europe and the rest of the world have adopted the PPP System to improve production and profitability.

Advantages of the PPP System:

- Save substantial time by printing, perforating and die-cutting, all in one operation
- Absolutely flat finished stock
- High production speeds
- Easy and fast installation
- Convenient handling and storage for further jobs
- No double setup on double-sized impression cylinder
- Wide range of applications
- All types of perforations, slitting, die-cutting, scoring (creasing), spot varnishing and spot printing are possible
- No wear of expensive blankets when perforating and die-cutting
- Reusable components



Another innovative product from H.S. Boyd, the foremost name in on-press perforating, slitting, scoring and die-cutting in the world.



H.S. BOYD COMPANY

HOW IT WORKS:



Simply mount the PPP-foil as a regular blanket. Put the PPP-base set underneath the foil and tighten to the recommended specifications.



Stick the self-adhesive tools (perf rules, dies or blanket) to the foil.

Stick the self-adhesive PPP-protection plate to the impression cylinder.



Back off the pressure at least 0.1 mm more than paper thickness and run a few sheets through the press. Increase pressure by small increments until a perfect perforation is achieved.

System Components

- PPP-Foil with grid
- PPP-Base Set – thickness depends on undercut
- Perforation, Slitting and Scoring Rules
- Dies – available in a variety of shapes and combinations with or without perforation rules
- Self-adhesive Blanket for spot varnishing and printing
- Accessory Rules and Protection Plates

PART #	LENGTH/QUANTITY	DESCRIPTION
Perforation Rules and Forms		
BOY-8101006	25", 5/Box	6-Tooth Centered Perf Rule
BOY-8101008	25", 5/Box	8-Tooth Centered Perf Rule
BOY-8101012	25", 5/Box	12-Tooth Centered Perf Rule
BOY-8105052	25", 5/Box	34-Tooth Centered Perf Rule
BOY-81BOM50	40", 5/Box	50-Tooth Centered Perf Rule
BOY-8101106	25", 5/Box	6-Tooth Side Series Perf Rule
BOY-8101108	25", 5/Box	8-Tooth Side Series Perf Rule
BOY-8101112	25", 5/Box	12-Tooth Side Series Perf Rule
BOY-8105024	1/Pkg.	6-Tooth Cross Perforation Form
BOY-8105025	1/Pkg.	8-Tooth Cross Perforation Form
BOY-8105101	1/Pkg.	12-Tooth Cross Perforation Form
BOY-8105040	1/Pkg.	6-Tooth Corner Perforation Form
BOY-8105026	1/Pkg.	8-Tooth Corner Perforation Form
BOY-8105039	1/Pkg.	12-Tooth Corner Perforation Form
BOY-8105037	1/Pkg.	6-Tooth T-Perforation Form
BOY-8105038	1/Pkg.	8-Tooth T-Perforation Form
BOY-8105065	1/Pkg.	12-Tooth T-Perforation Form
Slitting and Scoring Rules, Back Rules for Scoring, Forms		
BOY-8101013	25", 5/Box	Slitting Rule
BOY-8101015	25", 10/Box	Back Rule
BOY-81BO16C	25", 5/Box	Score – Card
BOY-81BO16P	25", 5/Box	Score – Paper
BOY-8105033	1/Pkg.	Cross Cutting Form
BOY-8105032	1/Pkg.	Corner Cutting Form
BOY-8105048	1/Pkg.	T-Cutting Form
Protection Plates, Self-adhesive		
BOY-8109024	12" x 3.4", 50/Pkg.	Self-adhesive Protection Plate
BOY-8109009	9.4" x 10.2", 20/Pkg.	Self-adhesive Protection Plate
BOY-8109010	10.2" x 18.9", 10/Pkg.	Self-adhesive Protection Plate
BOY-8109011	10.2" x 27.6", 1/Pkg.	Self-adhesive Protection Plate
BOY-9950010	396" x 12"	Self-adhesive Tape
BOY-01900012	19" x 19" x .037"	Self-adhesive Blanket
BOY-1023	N/A	PPP-Video

NOTE: Custom dies available



Interested in learning more about this system? Click on our web link #1211 or order a video from your dealer.



Lithco Inc.

9449 Jefferson Blvd., Culver City, CA 90232

Tel: 310-559-7770 ■ 800-454-8426

Fax: 310-559-6908 ■ 888-454-8426

Web: www.lithcoinc.com

Email: lithco@lithcoinc.com

